

# PD6928 ProtEX+ and VantageView+ Flow Rate/Totalizers

## Data Sheet



ProtEX+  
Aluminum Enclosure



ProtEX+  
Stainless Steel Enclosure



VantageView+  
Plastic Enclosure



IECEX C E

VantageView+ C E

- Fully-Approved Explosion-Proof & Intrinsically Safe Loop-Powered Flow Rate/Totalizers (ProtEX+)
- Loop-Powered Field-Mount Flow Rate/Totalizers (VantageView+)
- 4-20 mA Input Displayed with  $\pm 0.02\%$  of Full-Scale Accuracy
- 1.5 Volt Drop (4.7 Volt Drop with Backlight)
- 0.7" (17.0 mm) 5 Alphanumeric Characters Top Display
- 0.4" (10.2 mm) 8 Alphanumeric Characters Bottom Display
- 20-Segment Bargraph Standard
- CapTouch Through-Window Button Programming with Normal and Delayed Modes
- Loop-Powered Backlight with Red Backlight for Alarm Conditions
- 8-Digit Total & Grand Total Display, Up to 13 Digits Using Both Lines
- Display Rate & Total Simultaneously
- Automatic or Manual Batch Control
- Display Open Channel Flow with Programmable Exponent Feature
- 32-Point Linearization & Square Root Extraction
- (2) Open Collector Outputs Standard; Assignable to Pulse, Alarm, Timer, or Stopwatch
- (2) Optional Loop-Powered Solid-State Relays; Assignable to Alarm, Control, Timer, or Stopwatch
- Stopwatch & Timer Functions to Drive Relays & Open Collectors
- Optional Isolated 4-20 mA Analog Output
- Free PC-Based MeterView XL USB Programming Software
- Operating Temperature Range: -40 to 75°C (-40 to 167°F)
- Installation Temperature Range: -55 to 75°C (-67 to 167°F) (ProtEX+)
- Conformal Coated PCBs for Dust & Humidity Protection
- CSA Certified for Explosion-Proof / Dust-Ignition Proof / Flame-Proof (ProtEX+)
- ATEX and IECEx Certified as Intrinsically Safe and Explosion-Proof (ProtEX+)
- Explosion-Proof, IP68, NEMA 4X Die-Cast Aluminum & Stainless Steel Enclosures (ProtEX+)
- Plastic NEMA 4X, IP66 Enclosure (VantageView+)
- 3-Year Warranty

Watch the Loop-Powered  
Meters Video



Click or scan

**FLUIDPRO**

Dosing Systems

[www.fluidprodosingsystems.com.au](http://www.fluidprodosingsystems.com.au)

QLD 07 3071 7415 NSW 02 8069 2664 VIC 03 9021 6624

**PRECISION  
DIGITAL**

**VIDEO**



**The Most Comprehensive Line of Loop-Powered Indicators on the Market**

Precision Digital is broadening its line of loop-powered indicators to include three new product lines:

- PD6900 ProtEX+ Explosion-Proof Meters
- PD6900 VantageView+ General Purpose Field-Mount Meters
- PD4 Loop Leader+ Large Display Field-Mount Loop-Powered Meters

Learn all about these new series and see why Precision Digital now has the most complete line of loop-powered meters on the market!



Watch the Loop-Powered Meters Video  
*Click or scan*

**TABLE OF CONTENTS**

OVERVIEW . . . . . 3

DISPLAY FEATURES . . . . . 5

CAPTUCH THROUGH-WINDOW BUTTONS . . . . . 9

OUTPUTS . . . . . 10

BATCH CONTROL . . . . . 11

TOTALIZER CAPABILITIES . . . . . 14

INPUT SIGNAL CONDITIONING . . . . . 15

PHYSICAL FEATURES . . . . . 16

OPERATIONAL FEATURES . . . . . 19

METERVIEW XL PROGRAMMING SOFTWARE . . . . . 21

ACCESSORIES . . . . . 23

DIMENSIONS . . . . . 27

CONNECTIONS . . . . . 28

WIRING DIAGRAMS . . . . . 30

SPECIFICATIONS . . . . . 32

ORDERING INFORMATION . . . . . 35

**WHY USE LOOP-POWERED METERS?**

The most basic decision a user wishing to display a 4-20 mA signal on a digital display has to make is: should the meter be powered by line voltage or should it be powered by the 4-20 mA loop? The meters in this data sheet are powered by the 4-20 mA loop. The three main benefits of this are:

- No additional power required
- Easy wiring
- Additional digital displays can easily be added in the same loop

The diagram on the right illustrates how a loop-powered meter is wired. Notice there are only two connections made to the meter.

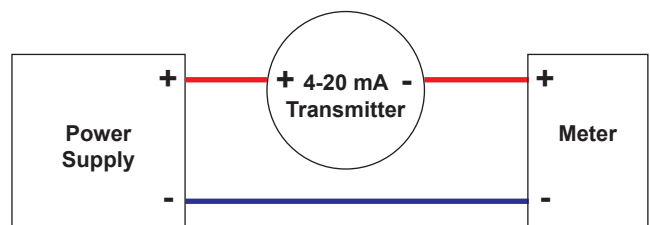

For more information on loop-powered meters, check out these white papers:

[Fundamentals of Loop-Powered Devices](#)

[Loop-Powered vs Line-Powered Meters](#)

OVERVIEW

ProtEX+ Series

**Front**





**PD6928-HA-AL**  
**Flow Rate/Totalizer**  
**Aluminum**



**PD6928-HA-SS**  
**Flow Rate/Totalizer**  
**Stainless Steel**

---

**Connections**

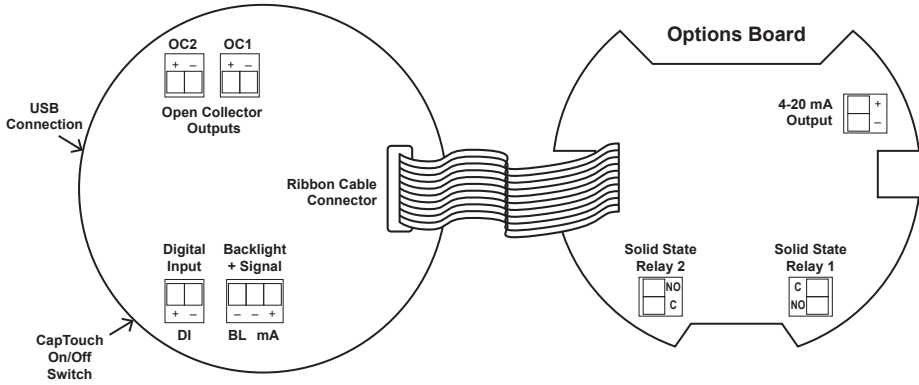

**Connections for -L5N Option**

**Options Board**

4-20 mA Output



Solid State Relay 2



Solid State Relay 1



**Standard**

- (2) Open Collector Outputs Standard (150 mA max); Assignable to Pulse, Alarm, Timer, or Stopwatch
- Digital Input for Remote Operation of a Single Task

**Options**

- (2) Loop-Powered Solid-State Relays; Assignable to Alarm, Control, Timer, or Stopwatch
- Isolated 4-20 mA Analog Output

**Hazardous Area Loop-Powered Flow Rate/Totalizers with Advanced Display and Control**

The ProtEX+ loop-powered explosion-proof & intrinsically safe flow rate/totalizer can be installed virtually anywhere to provide convenient and informative display of any 4-20 mA signal. They can operate down to -40°C and be installed in areas that get as cold as -55°C, however the display will cease functioning. One of the most convenient features is the dual-line display, typically used to display the flow rate on the 5-character alphanumeric top display and flow total, flow grand total, or tag on the 8-character alphanumeric bottom display. The top display uses 12-segment, and the bottom display uses 14-segment alphanumeric characters for clear indication of tags, units, or alarm messages. Further enhancing the display on these instruments is a 20-segment bargraph.

The ProtEX+ Series is CSA Certified for Explosion-Proof / Dust-Ignition Proof / Flame-Proof and ATEX and IECEx Certified as Intrinsically Safe and Explosion-Proof.

Four CapTouch through-glass buttons are available to operate the instrument without removing the cover. Free, PC-based, MeterView XL software that connects to the meter via a micro USB cable is available for programming and setup of the meters.

All models come equipped with two open collector outputs and a digital input. There are also models available with two solid-state relays and isolated 4-20 mA analog output options. The relays can be programmed for alarm indication, sample, timer, batch control, or stopwatch.

VantageView+ Series

Front



PD6928-GP-PL  
Flow Rate/Totalizer  
Plastic

---

Connections

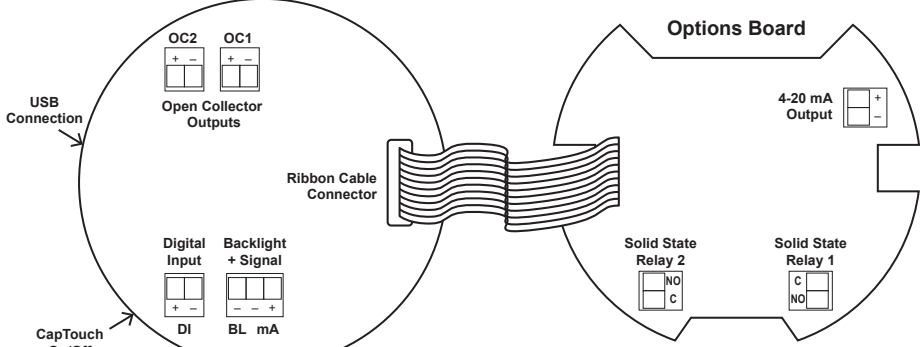

Connections for -L5N Option

**Standard**

- (2) Open Collector Outputs Standard; Assignable to Pulse, Alarm, Timer, or Stopwatch
- Digital Input for Remote Operation of a Single Task

**Options**

- (2) Loop-Powered Solid-State Relays; Assignable to Alarm, Control, Timer, or Stopwatch
- Isolated 4-20 mA Analog Output

**Standard**

- (2) Open Collector Outputs Standard; Assignable to Pulse, Alarm, Timer, or Stopwatch
- Digital Input for Remote Operation of a Single Task

**Options**

- (2) Loop-Powered Solid-State Relays; Assignable to Alarm, Control, Timer, or Stopwatch
- Isolated 4-20 mA Analog Output

**General Purpose Loop-Powered Flow Rate/Totalizers with Advanced Display and Control**

The VantageView+ loop-powered flow rate/totalizer can be installed in a variety of harsh operating environments to provide convenient and informative display of any 4-20 mA signal. One of the most convenient features is the dual-line display which is typically used to display the flow rate on the 5-character alphanumeric top display and flow total, flow grand total, or a tag on the 8-character alphanumeric bottom display. The top display uses 12-segment, and the bottom display uses 14-segment alphanumeric characters for clear indication of tags, units, or alarm messages.

Further enhancing the display on these instruments is a 20-segment bargraph.

Four CapTouch through-window buttons are available to operate the instrument without removing the cover. Free, PC-based, MeterView XL software that connects to the meter via a micro USB cable is available for programming and setup of the meters.

All models come equipped with two open collector outputs and a digital input. There are also models available with two solid-state relays and isolated 4-20 mA analog output options. The open collector outputs are useful for alarm indication or pulse output. The digital input can be used to remotely reset the total, to start/stop a timer/stopwatch, and more. The relays can be programmed for alarm indication, sample, timer, batch control, or stopwatch.

**DISPLAY FEATURES**

**PD6928 Flow Rate/Totalizer with Bargraph**

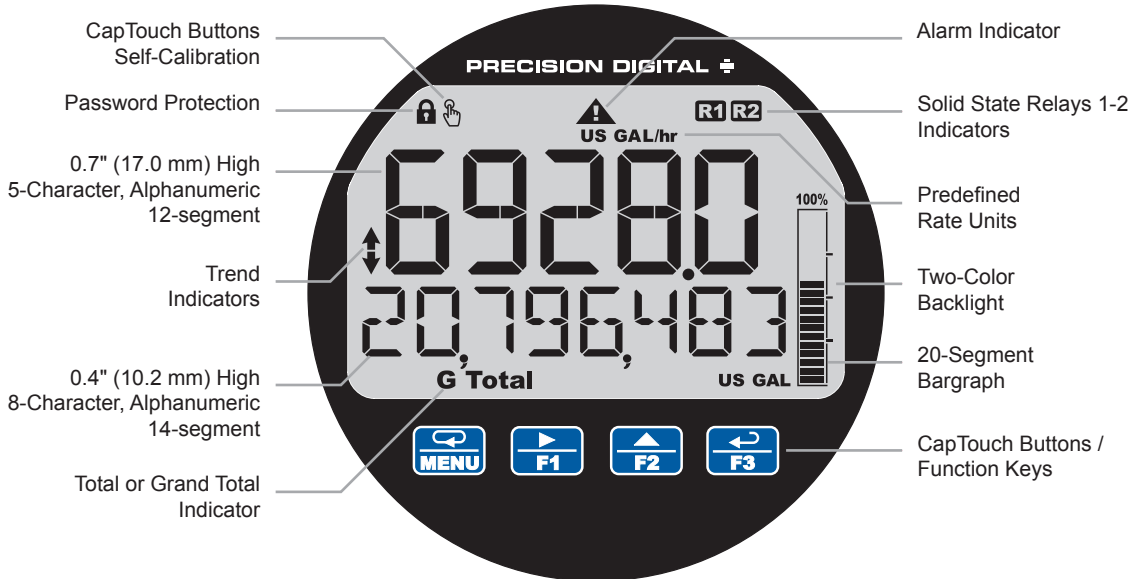

14-Segment Characters on Bottom Display Provide Clearer Readings of Units or Tags



**Display Flow Rate & Total at the Same Time**

One of the key features of these rate/totalizers is their ability to display flow rate and total at the same time. In addition, the meter can toggle between the rate and total and their corresponding units as the following illustrates.

**Display Flow Rate & Total and Toggle Between Units**

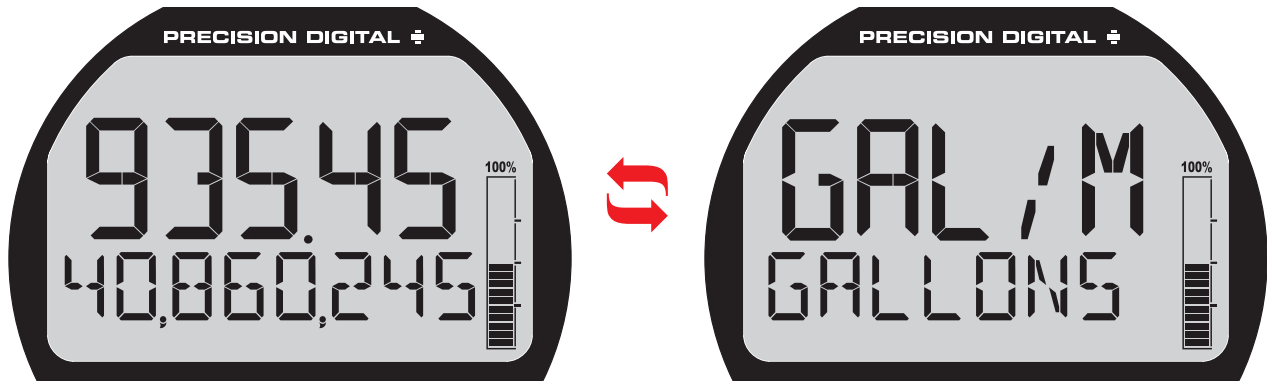

Flow Rate on Top & Total Flow on Bottom

Rate Units on Top & Total Units on Bottom

### Wide Variety of Display Capabilities

In addition to the most common setup of flow rate on the top display and flow total on the bottom display, these meters can be set up for a variety of display configurations.

#### Display Flow Rate and Toggle Between Units & Tag

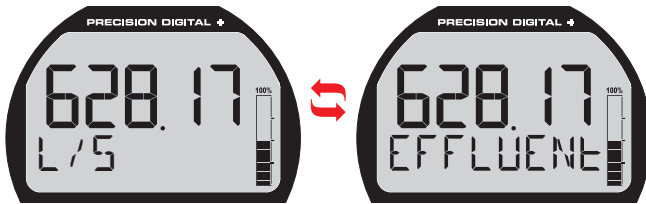

Flow Rate on Top  
Rate Units on Bottom

Flow Rate on Top  
Tag on Bottom

#### Display Flow Total and Toggle Between Units & Tag

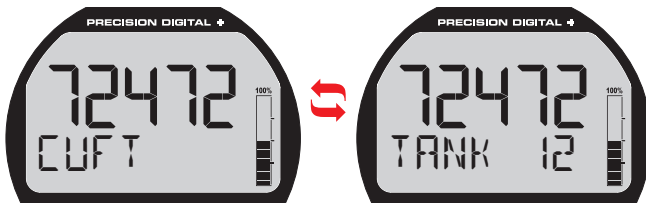

Total Flow on Top  
Total Units on Bottom

Total Flow on Top  
Tag on Bottom

#### Display Flow Total & Flow Grand Total and Toggle Between Units

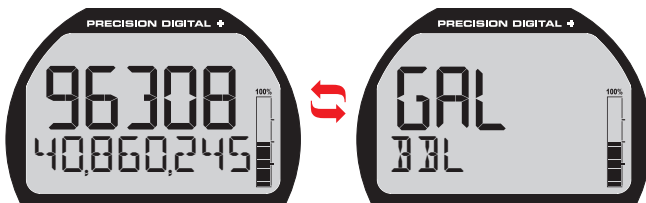

Total Flow on Top  
Grand Total Flow on Bottom

Total Units on Top  
Grand Total Units on Bottom  
(note different units than Total)

The following table shows the items that can be displayed on the Top and Bottom lines:

Top (TOP) Line Can Display	
Off (Blank)	Preset batch value
Rate	Stopwatch
Rate and its units alternating	Timers OC and relays
Total	Min
Total and its units alternating	Max
Tag	Min & max
Units	
Bottom (BOTTOM) Line Can Display	
Off (Blank)	Tag
Total (with units or tag alternating)	Total, its units, and the rate and units alternating
Grand total (with units or tag alternating)	Grand total, units, and rate units alternating
Rate (with units or tag alternating)	Rate's percentage of max scale
Rate and the total's units alternating	Rate or total units
mA input value	mA output value
Units for value on top line	Preset batch value
Tag and total units alternating	Tag and rate units alternating
Alarm Message	

### 14-Segment Characters

Notice how much better characters like “/” and “m” appear as 14-segment characters on the bottom display vs. 7-segment characters found on other meters.



7-Segment



14-Segment

### Dual-Scale Display Feature

Users can use the dual-scale feature when they want to show the same input in two different scales. For instance, the following example shows an application where the meter displays the input in gallons per minute and cubic feet per minute.

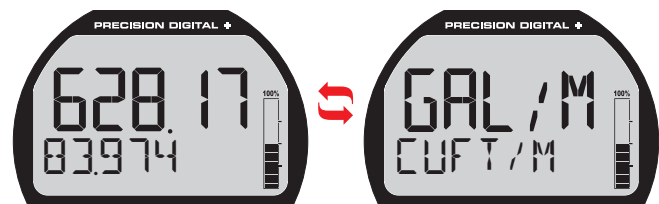

Rate in GPM on Top  
Rate in CFM on Bottom

GPM Units on Top  
CFM Units on Bottom

### 2X More Informative Display

The PD6928 Series display offers a 50% larger display area and is twice more informative than previous generations of loop-powered meters. Featuring an alphanumeric dual-line display and a 20-segment bargraph, reading and understanding process values is easy and intuitive. The addition of status indicators provides a quick glance at alarm conditions, relays, process trends, and more. Predefined display units give users even more display flexibility.

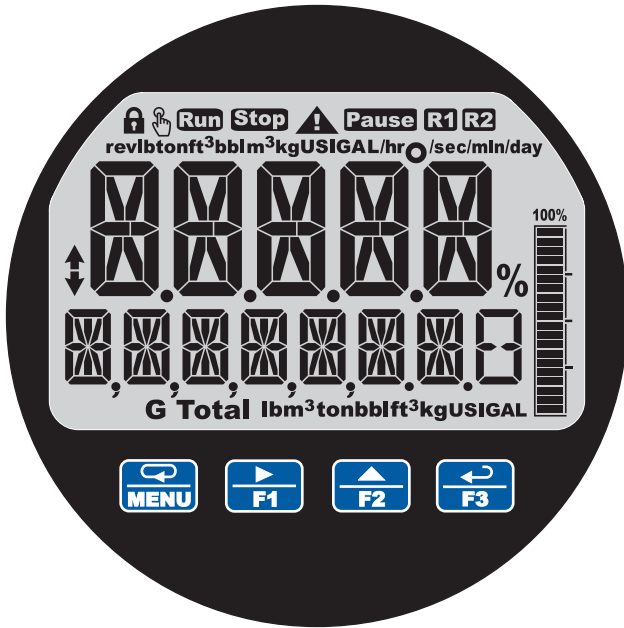

Indicator	State	Description
↕	Steady	Process trend arrows
⚠	Flashing	Alarm Indicator
🔒	Steady	Password protected
R1	Steady	Solid-state relay 1
R2	Steady	Solid-state relay 2
👆	Flashing	CapTouch buttons self-calibrating (wait)
▬	Steady	PV Bargraph
▬	Flashing	Alarm condition: Bargraph segment flashes on alarm
<b>Total</b>	Steady	Displaying Total
<b>G Total</b>	Steady	Displaying Grand Total
<b>Run</b>	Steady	Batch is running
<b>Run</b>	Flashing	Automatic batch control: Batch paused or start delayed
<b>Stop</b>	Steady	Batch is stopped
<b>Pause</b>	Steady	Batch is paused

### Commas Make it Easy to Read Big Numbers

The bottom display is set to show a comma separating the thousands and millions place by default if a numeric value is being displayed. This feature can be disabled or enabled using the *Comma* menu.

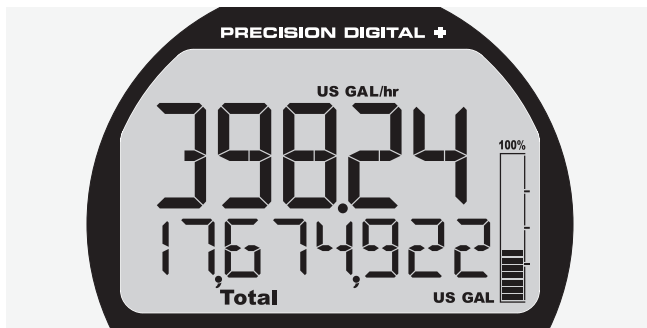

### Red, Flashing Display Gets People's Attention When Alarms Occur

When an alarm occurs, the display can be programmed to turn red, flash, and display an alarm indicator ⚠. In addition, a unique custom alarm message for each of the two relays and two open collectors can be displayed on the bottom display. These features can be activated even if no relay or open collector is connected.

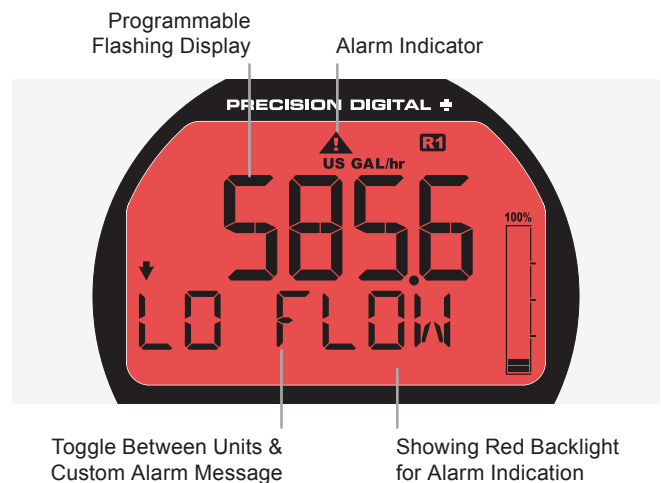

### Backlight Turns Red on Alarm

The loop-powered backlight is standard on all ProtEX+ and VantageView+ meters. It provides optimum visibility in any lighting condition and it can be programmed to turn red for alarm conditions. The backlight may be enabled or disabled using the *Backlight* menu. The backlight is enabled by default (input must be wired appropriately for the loop-powered backlight to function).

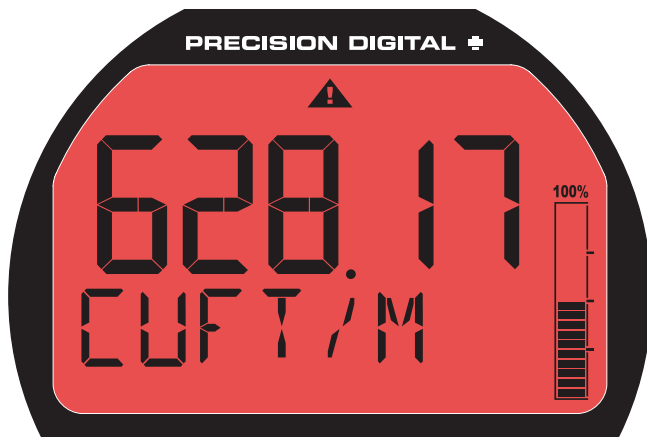

Backlight for Visibility in Any Lighting Condition and Red Backlight for Alarm Indications

### Bargraph Provides Quick Understanding

The 20-segment bargraph helps users get a quick understanding of where their process is at. The bargraph can be programmed to represent either rate, a percentage of the rate, total, or it can be disabled.

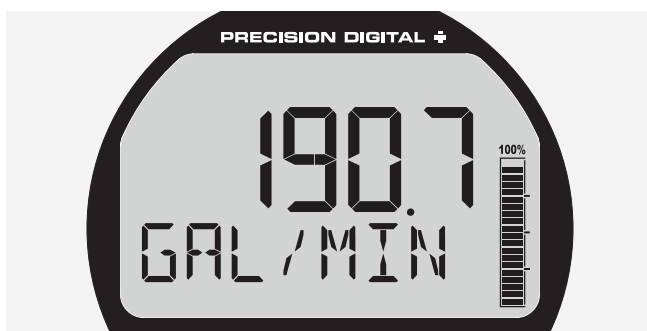

Bargraph indicating rate in gallons/minute

### Total & Rate in Different Units

The user can select to display total in different units than the rate. For instance, a customer could measure flow rate in gallons per minute and total in acre-feet by simply selecting AF (acre-feet) units for the total. Additionally the user can enter a custom unit and conversion factor to display the total in any unit of measure.

### Max/Min Display

The max & min readings (peak & valley) reached by the process can be displayed either continuously or momentarily.

- Display momentarily by pressing the F1 function key (default) or assigning to any of the other function keys or to the digital input in the User menu. Press Enter to lock/unlock max/min display.
- Display continuously by assigning either display line to max/min through the Display menu.

Any of the F1-F3 function keys (buttons) and the digital input can be programmed to reset the max & min readings.

Top Display: Process Value  
Bottom Display: Max & Min

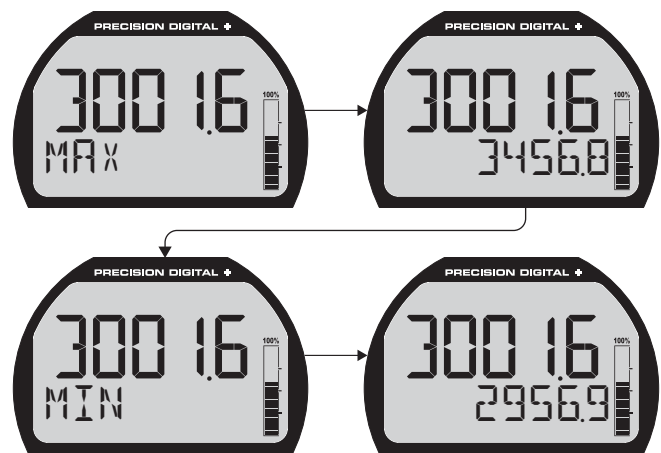

### Using 13 Digits to Display Total

The top and bottom displays can be setup to display a 13-digit total (9,999,999,999,999). The total will roll over to zero when it exceeds the limit.

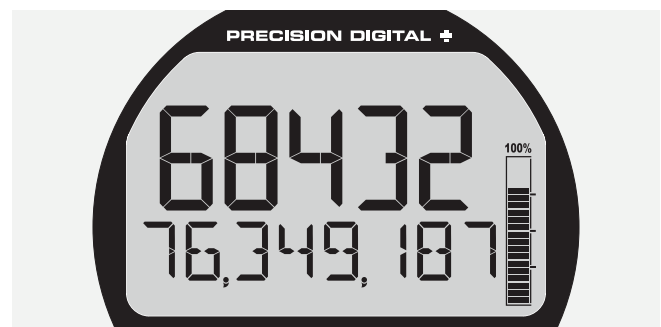

The number above should be read as 6,843,276,349,187

### Predefined and Custom Units

The meter has the most common predefined rate and volume units. If the desired unit is not available, the user can program a custom unit.



## CAPTOUCH THROUGH-WINDOW BUTTONS

All PD6928 meters are equipped with four capacitive sensors that operate as through-window buttons so that they can be operated without removing the cover (and exposing the electronics) in a hazardous area. CapTouch buttons are designed to work under any lighting condition and to protect against false triggering. They can be turned off for security via a switch on the display module.

To actuate a button, press one finger to the window directly over the marked button area. When the cover is removed, the CapTouch buttons can be used after the meter completes a self-calibrating routine (⚡ flashes). The sensors are disabled when more than one button is pressed, and they will automatically re-enable after a few seconds (⚡ off).







Capacitive touch technology



More reliable & responsive



Two modes of operation



Operate meter without removing the cover

### CapTouch Buttons Operation Modes

The CapTouch buttons have two modes of operation: *Normal* and *Delayed*.

#### Normal

Normal is the factory default setting. This mode is recommended for programming the meter or when immediate operation of the buttons is needed.

#### Delayed

Use the Delayed mode to prevent accidental trigger of the buttons. In the Delayed mode, the buttons enter into a low sensitivity state (sleep) and they ignore quick button presses after 20 seconds of inactivity. To wake up the buttons, press and hold any button for more than 2 seconds, the buttons respond normally.

### Turning Off CapTouch Buttons

The CapTouch buttons can be turned off for security by moving the slide switch located on the display module to the Off position.



## OUTPUTS

PD6928 meters come with two open collector outputs as standard and two solid-state relays and 4-20 mA output as options. The open collector outputs and relays generally operate in the same manner, with the major exception being the open collectors are not available for batch control and the relays are not available with pulse output features. The open collectors and relays can be controlled either automatically or manually. The alarm status (with a unique flashing red message for each of the two relays and open collectors) will show on the display even with no output wired.

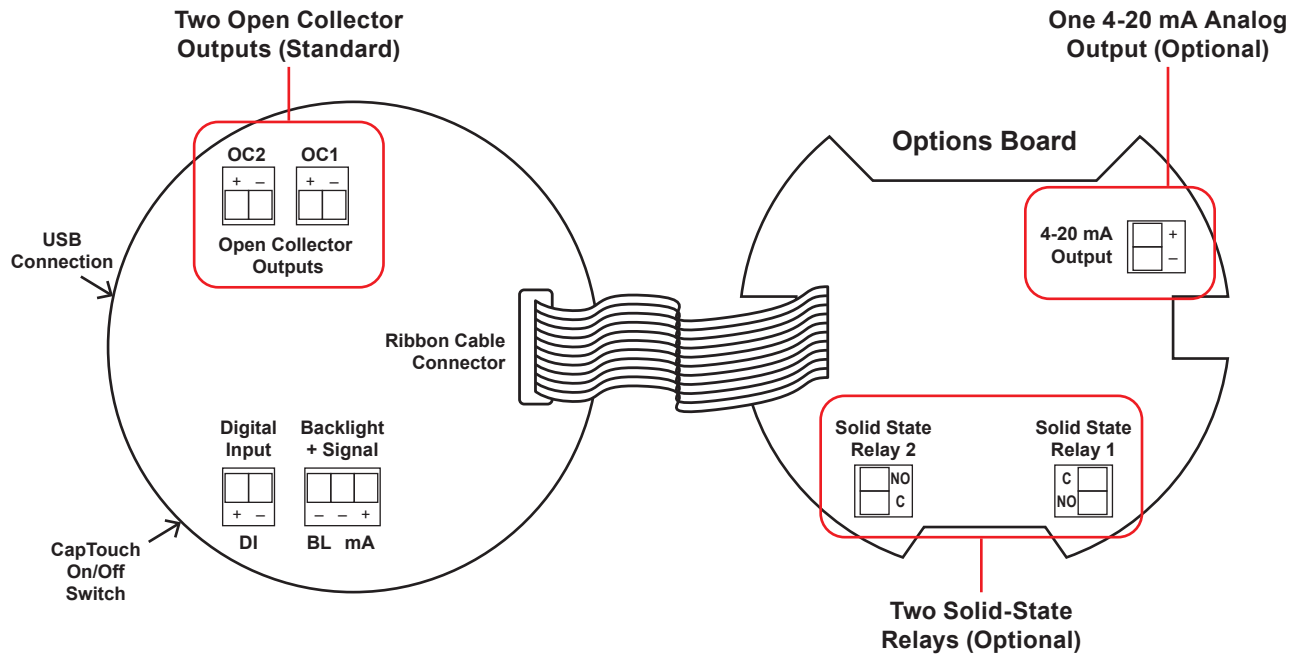

### Two Open Collector Outputs

The meter is equipped with two NPN open collector outputs that may be set up for pulse outputs, alarms, timed pulses, stopwatch on/off, or disabled. Pulse outputs can be set to transmit the rate, total or grand total. Output 2 may be used to generate a quadrature output based on the other open collector output. An output test mode is also selectable to generate pulses at a constant programmable frequency. The open collectors are commonly used to generate a pulse for every user-defined amount of flow that has been generated. For instance, the meter can be programmed to generate a pulse for every 100 gallons of flow.

### Two Optional Solid-State Relays

The meter is optionally equipped with two solid-state relays that may be set up for alarms, sample, timer, batch control, or stopwatch. The relays are rated at 250 VAC/DC @ 0.5 A for resistive loads and 38 VA @ 0.3 A, 250 VAC/DC max (Safe Area only) for inductive loads. Alarms are available based on the PV value or the digital input.

### Optional Isolated 4-20 mA Output

The isolated analog output signal can be configured to represent the rate, total or to retransmit the 4-20 mA input signal without the need to scale the output. While the

output is nominally 4-20 mA, the signal will accurately accommodate under- and over-ranges from 1 to 23 mA. The output can be reverse scaled such that the meter's high calibration value outputs 4 mA and the meter's low calibration outputs 20 mA.

### Loop-Powered Relay Alarm Trip for General Purpose & Hazardous Areas

The two solid-state relays can be used as a loop-powered relay alarm trip in both general purpose and hazardous areas. The meter's two relays can be programmed for two different kinds of latching operation: Reset via momentary contact closure at any time or reset via momentary contact closure only after the alarm has cleared. And the meter's display can be programmed to turn red and flash a unique custom alarm message for each relay – something not found on most loop-powered alarm trips.

### Sampling Relay

A relay set to sample will trigger when the total or grand total value has incremented by a programmed amount. The relay can be programmed to stay on for a specified amount of time. For example: if a relay is set to sample the total with a COUNT of 1,000 and a TIME of 10 seconds, the relay will energize for 10 seconds each time the total increments by 1,000 (e.g. 1000, 2000, 3000).

### Resetting the Open Collectors and Relays

The open collectors and relays (alarms) may be programmed to reset in the following ways:

- **Automatic (AUTO):** Alarm will reset automatically once the alarm condition has cleared.
- **Automatic/Manual (AUTOMAN):** Alarm will reset automatically once the alarm condition has cleared but can also be reset using the Enter button (or whichever function key is set to acknowledge) at any time.
- **Latching (LATCH):** Alarm must be reset manually and can be done so at any time. Press the Enter (ACK) button at any time to clear the alarm.
- **Latching with Reset after Cleared (L-CLEAR):** Alarm must be reset manually and can only be done so after the alarm condition has cleared. Press the Enter (ACK) button after the alarm condition has cleared to reset the alarm.

### Timer Function

Timers are used in everyday life; one of the most common examples is the microwave oven. Industrial timers are used in process control applications where certain events or actions need to be controlled by time. Examples include automatic batch control applications, where the relay needs to be energized for a specific length of time.

The timer function is available on the open collector and relay outputs; which means that you can have up to four timers per meter. The start and stop actions can be triggered from the setup menu or by the function keys and digital input. The meter can be setup to display the off/on timer count down.

There are two modes of operation:

- **Continuous Timer (Interval)**  
At the start of the timer the output is off and turns on after the Off Delay elapses. The output remains on for the duration of the On Time. The cycle repeats until the user stops the timer either from the menu or a function key.
- **One-Shot Timer**  
At the start of the timer the output is off and turns on after the Off Delay elapses. The output remains on for the duration of the On Time. The timer stops and the cycle does not repeat.

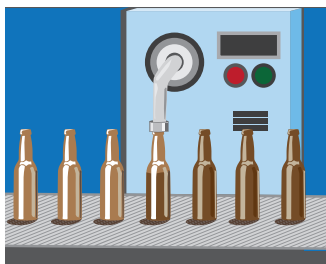

1. A sensor detects the bottle is in place and triggers the digital input to start the timer
2. The timer output controls the filling pump
3. The On Time is set according to the time needed to fill the bottle

### BATCH CONTROL

The PD6928, when ordered with the two solid-state relays, can be used as a simple, one or two-stage batch controller. The user enters a preset and preclose value and sets the meter to either count up or count down. The top display will show the total and the bottom display will show the preset batch amount. The function keys are automatically changed so that F1 starts a batch, F2 opens the preset menu to allow the preset value to be changed, and F3 pauses/stops the currently running batch. Batching can be either automatic or manual.

### Batch Control Operation Example

The following example shows how two-stage manual batch control functions with a PD6928. This setup will establish a 55-gallon preset for the batch, with a main valve (high flow) that will close at 50 gallons, and a trickle valve (low or restricted flow) that will close at 55 gallons. Because the first batch overruns by 0.10, the batch preset will be changed to 54.90 for the next batch to compensate for overrun.

### Two-Stage Manual Batch Control Setup Using Relays 1 and 2

Parameter	Setting	Function
RELAY OUTPUT 1	RLY 1 BATCH	Press Enter to assign relay 1 batch parameters.
BATCH COUNT	UP or DOWN	Setup batch to count up or down.
BATCH MAXIMUM	10000 GAL	This setting prevents the operator from entering a preset value that exceeds a safety limit for the batch process.
BATCH MODE	MANUAL AUTO	Press Enter to select manual or automatic batch control.
BATCH PRESET	55.00 GAL	Enter the batch size.
BATCH DELAY	ON & OFF	Enter the On & Off time delays for relay 1, if desired.
RELAY OUTPUT 2	RLY 2 BATCH	Press Enter to assign relay 2 batch parameters.
BATCH PRECLOSE	YES PRECLOSE 500	Set the pre-close value to 5 to close the valve being controlled by relay 2 so it closes five gallons before reaching the preset.
BATCH DELAY	ON & OFF	Enter the On & Off time delays for relay 2, if desired.
RELAY MESSAGE	MSG RELAY 1	Enter a message to be displayed while relay 1 is on, if desired.
	MSG RELAY 2	Enter a message to be displayed while relay 2 is on, if desired.

If only one-stage batch control is desired, do not assign relay 2 to batch. The following pages show illustrations of how the above settings control the batch operation. The display assignment shown is the default.

**Manual Batch Control**

The manual batch control feature is used for batch processes that the operator wants to start manually. It can also be used where the batch size needs to be manually adjusted for each batch. The batch can be controlled by the button on the meter or the digital input.

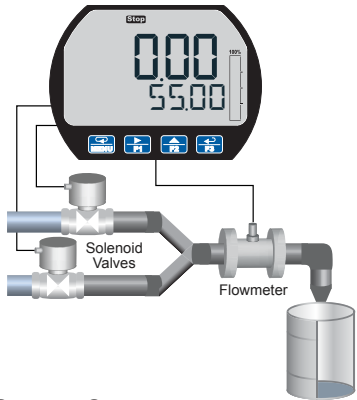

**System Setup**

Both valves are closed with an empty barrel in place. The batched total is displayed in the upper display, the preset is selected for the lower display.

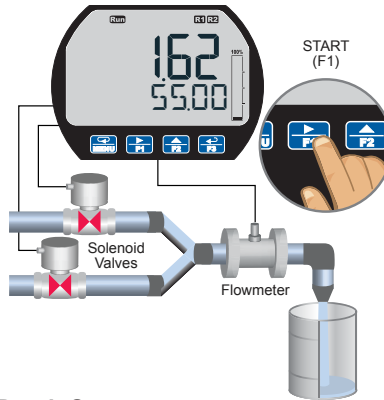

**Batch Start**

The START button or (F1) is pressed. Both valves open. The barrel begins to fill.

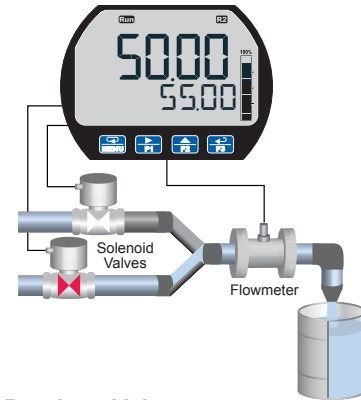

**Preclose Valve**

When the batch total reaches a value of 50.00 (Preset [55.00] – Pre-close [5.00]) the full-flow valve closes. The fill rate of the tank slows as a result.

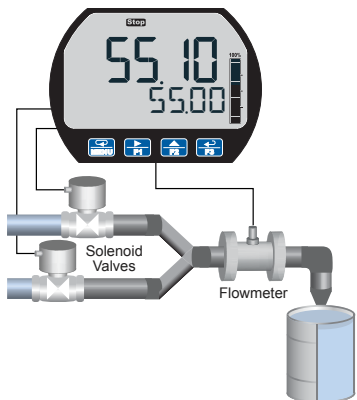

**Completed Batch**

When the batch is complete, the restricted flow valve closes. If overrun occurs, then the preset must be adjusted to compensate for the overrun amount. The next batch will only start after the START button or (F1) is pressed.

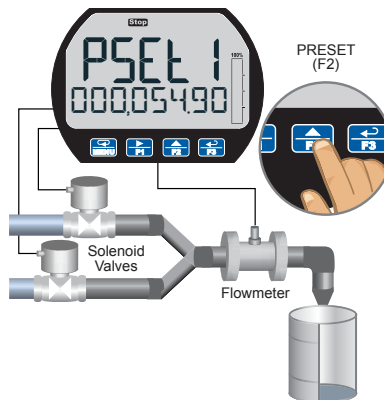

**Overrun Correction**

To compensate for overrun in the previous batch, adjust the preset to 54.90, so that the next batch is accurate (55.00).

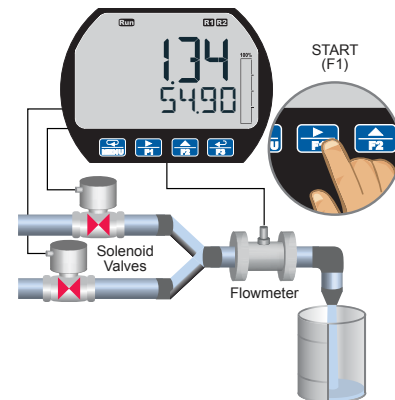

**Manual Start of Next Batch**

A new, empty, barrel is put in place and the START button or (F1) is pushed to manually start the next batch.

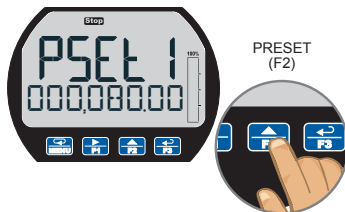

**Change Batch Size**

While the process is stopped, a new preset fill amount may be selected with the Batch key (F2) for a different size barrel.

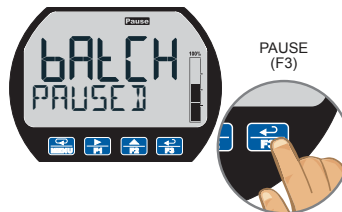

**Pause/Stop**

At any time, press the STOP button or Stop key (F3) once to pause the process, or twice to cancel the batch, which stops the process.



**Resume Batch**

If the batch has been paused, then press START button or (F1) to resume the batch process.

**Automatic Batch Control**

The automatic batch control feature is used for batches that start automatically once the previous batch is completed. There is no opportunity for the operator to change the batch size between batches. The batch can be controlled by the button on the meter or the digital input.

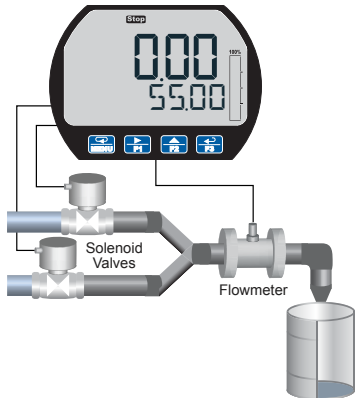

**System Setup**

Both valves are closed with an empty barrel in place. The batched total is displayed in the upper display, the preset is selected for the lower display.

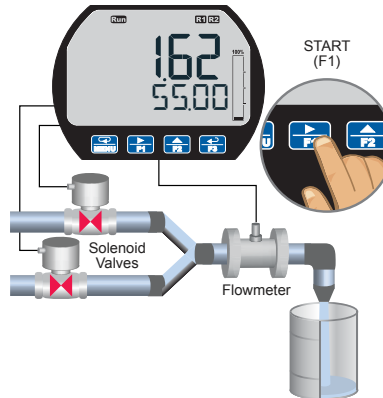

**Batch Start**

The START button or (F1) is pressed. Both valves open. The barrel begins to fill.

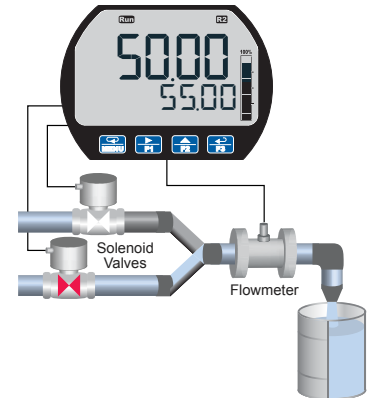

**Preclose Valve**

When the batch total reaches a value of 50.00 (Preset [55.00] – Pre-close [5.00]) the full-flow valve closes. The fill rate of the tank slows as a result.

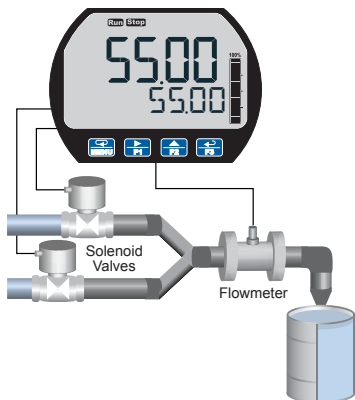

**Completed Batch**

When the batch is complete, the restricted flow valve closes. If overrun occurs, then the preset must be adjusted to compensate for the overrun amount.

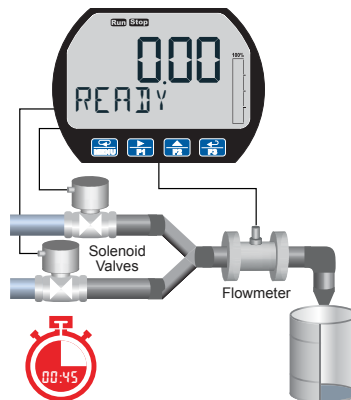

**Start Delay**

After the batch is completed, the operator removes the full barrel and places an empty barrel; the new batch starts automatically after 60 seconds (Time Delay).

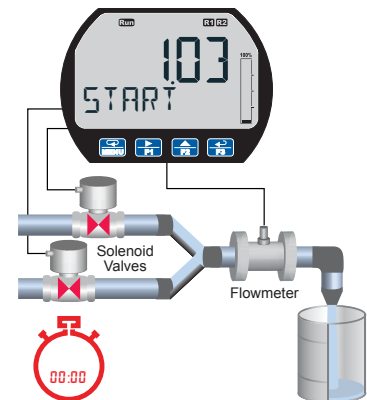

**Automatic Start of Next Batch**

The next batch begins automatically after 60 seconds, both relays activate and both valves open.

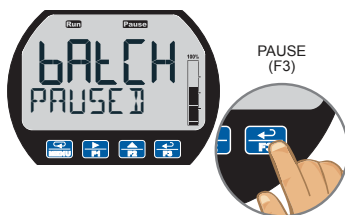

**Pause**

At any time, press the STOP button or Stop key (F3) once to pause the process.



**Resume Batch**

If the batch has been paused, then press START button or (F1) to resume the batch process.

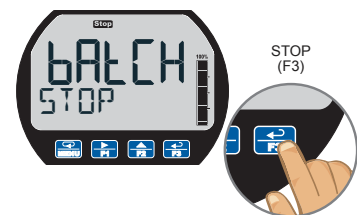

**Stop Process**

At the end of the shift, press STOP button or Stop key (F3) twice to stop the batch process.

## TOTALIZER CAPABILITIES

PD6928 flow rate/totalizers can be programmed for a wide variety of totalizer applications. They can display total, grand total, or non-resettable grand total; the rate can be displayed with a time base of seconds, minutes, hours or days. The user can program a totalizer conversion factor, a non-resettable grand total, password protection, and several total reset methods.

### 8-Digit Total & Grand Total Display, Up to 13 Digits Using Both Lines

The flow rate/totalizer can be programmed to show eight full digits of total on the bottom display or 13 digits of total using both the top and bottom displays. In both cases, the display can be programmed to include commas to make it easier to read the very large numbers; ie 44,987,356.

In 13-digit mode, the bottom line shows the least significant digits and the top line shows the most significant digits. The meter is not capable of displaying commas on the top line, so this number is actually 1,211,230,379. The commas can be removed from bottom if desired. See sample on bottom, right.

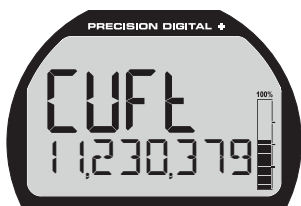

8 Digits of Total on Bottom

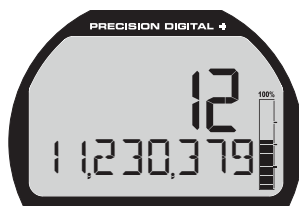

In 13-Digit Mode

### Totalizer Conversion Factor & Multiplier

The user can enter a totalizer conversion factor that allows the meter to display total in different units than the rate. For instance, a customer could measure flow rate in gallons per minute and total in millions of gallons. A multiplier may be selected to automatically display the value in kGAL, MGAL, etc. Use the custom units to display the total in any unit of measure including units in languages other than English.

### Totalizer Password Protection

The total and grand total can be password protected so they can be reset only by authorized personnel

### Non-Resettable Grand Total

The user can set up the grand total to be non-resettable by selecting YES for PERMLOCK in the *Advanced - Grand Total - Reset* menu. Once this is done, the grand total can never be reset.

### Low-Flow Cutoff

The user may program the meter for a low-flow cutoff such that the meter displays zero below this point, regardless of the input value.

### Remote Total Reset

The total can be reset via an external contact closure on the digital input.

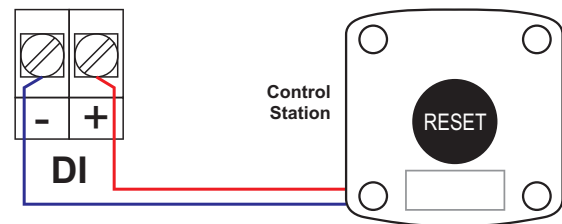

### Front Panel Total Reset

The three front panel function keys can be programmed to reset the total and grand total. This makes it possible for the user to reset either the total or the grand total by pressing the appropriate function key. Of course, if the total or grand total is password protected, they will not reset when the function key is pressed unless the password is entered.



F2 Function Key is Programmed for Reset by Default

### Total Alarms

The two open collectors and the two relays can be set up to alarm when the total reaches a user-defined set point. A variety of reset modes are available and the user can also program time delays and fail-safe operation.

### Total Stored in Non-Volatile Memory

Total and grand total values, and all programmed settings are stored in non-volatile memory for a minimum of ten years if power is lost.

## INPUT SIGNAL CONDITIONING

To satisfy applications that require scaling in ways other than the usual 2-point linear method, the PD6928 can also be scaled for square root (differential pressure flow), or programmable exponent (open channel flow).

For existing processes that require these linearization capabilities, one of the great benefits of loop-powered meters is that they get their power directly from the 4-20 mA loop and thus require no additional wiring. All a user has to do is break the existing loop and wire in the meter. For this reason, loop-powered meters are very easy to add to existing applications such differential pressure or open channel flow.

### Differential Pressure Flow

The PD6928 can display flow rate and total by extracting the square root from the 4-20 mA signal from a differential pressure transmitter. The user selectable low-flow cutoff feature gives a reading of zero when the flow rate drops below a user selectable value.

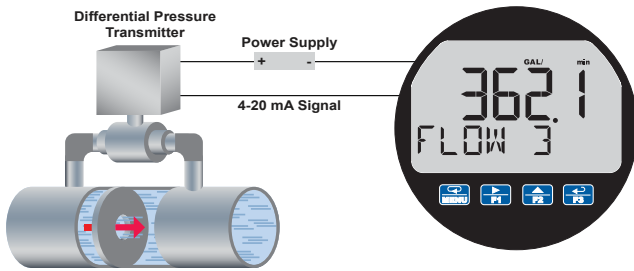

### Open Channel Flow

The PD6928, in combination with an ultrasonic level transmitter, makes for an economical way to measure and display open channel flow rate in most weirs and flumes. A guide such as the ISCO Open Channel Flow Measurement Handbook can provide the user with all the information needed: the exponent used in the flow equation for the desired flow units and the flow rate for any given head height. For example, to display the open channel flow rate from a 3" Parshall flume, the ISCO handbook advises the exponent is 1.547 and at the maximum head height of 3.0 feet, the flow rate is 3.508 MGD.

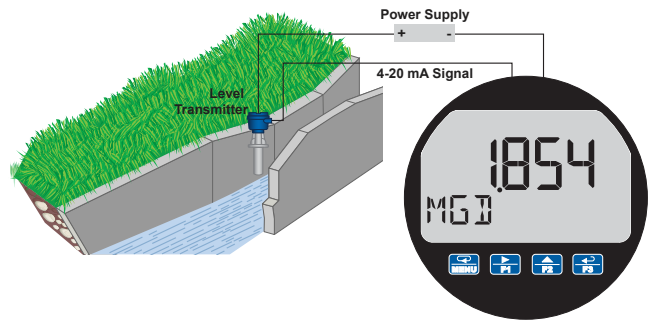

### Multi-Point Linearization

Meters are set up at the factory for linear function with 2-point linearization. Up to 32 linearization points can be selected for rate under the linear function. Multi-point linearization can be used to linearize the input for non-linear signals to convert level to flow using weirs and flumes with complex equations.

MeterView XL makes it easy to program up to 32 points.

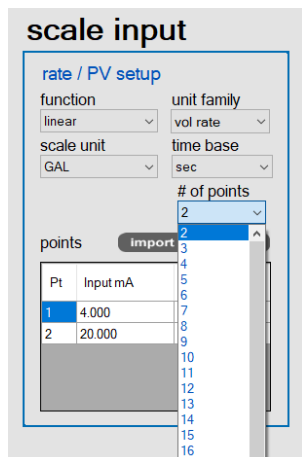

Function	Desire	Programming
Open Channel Flow	3" Parshall flume	Set Programmable Exponent to 1.547
Flow Rate	Millions of Gallons per Day (MGD)	Set 4 mA = 0 & 20 mA = 3.508 Time base = Day
Total	Millions of Gallons	Set Totalizer Conversion Factor = 1 (password protect total reset)
Non-Resettable Grand Total	Program meter so grand total can never be reset	Set non-resettable grand total
Display	Display Flow Rate and Total at the same time	Set upper display for Grand Total and lower display to toggle between rate and total.
Sampling	Take a 1 pint sample every 100,000 gallons	Set up relay for sampling and to trip every 0.1 million gallons. Set up sampling time such that 1 pint is sampled.

**PHYSICAL FEATURES**

**ProtEX+ Aluminum & Stainless Steel Enclosures**

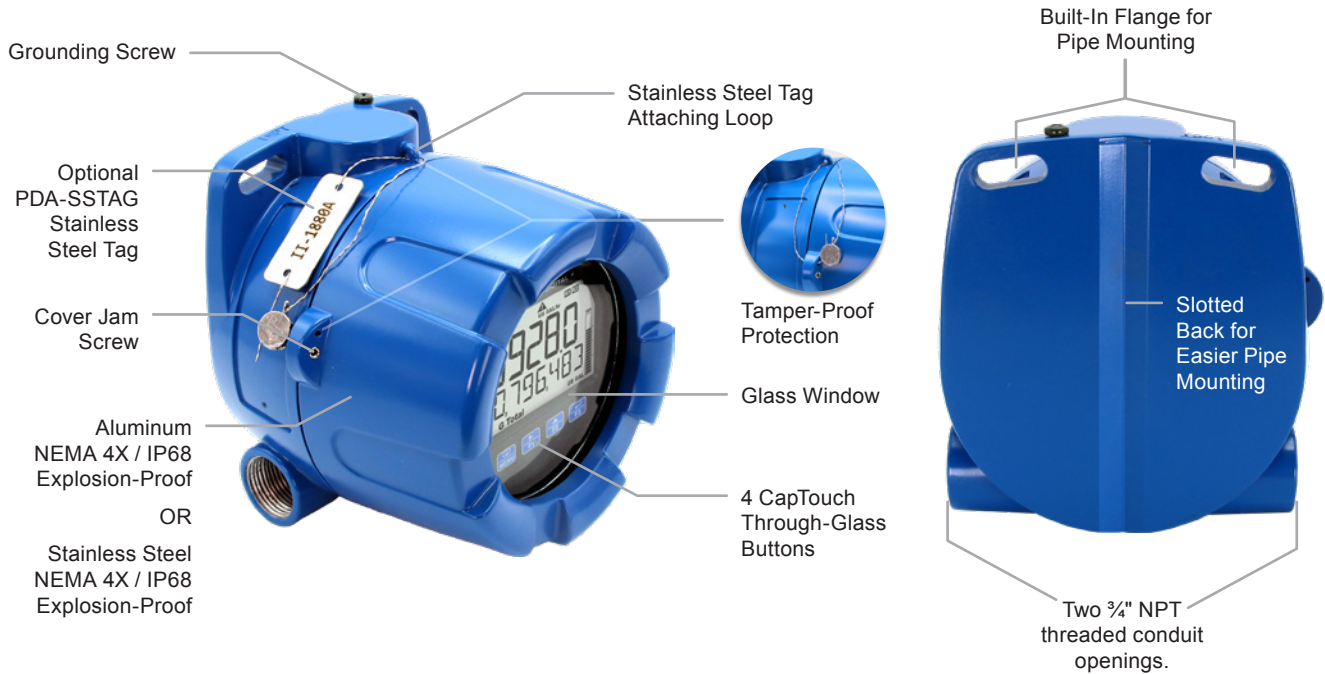

**VantageView+ Plastic Enclosure**





### NEMA 4X Enclosures

Both ProtEX+ and VantageView+ enclosures provide serious protection from the elements, high impact, corrosion, and dust. The ProtEX+ is NEMA 4X/IP68 rated, and VantageView+ is NEMA 4X/IP66. In addition, the ProtEX+ enclosure provides protection against electrical interference and its extensive worldwide agency approvals allow it to be installed virtually anywhere.



### Easy Pipe Mounting

Both ProtEX+ and VantageView+ come with a built-in flange. This allows easy mounting to walls or pipes using either a [PDA6846](#) Zinc Plated Steel or a [PDA6846-SS](#) Stainless Steel 2" U-Bolt Kit. A slot on the back of the enclosure makes it easy to center the unit on a pipe.



### Stainless Steel Tag Attaching Loop

The enclosure is equipped with a loop at the top to easily attach a PDA-SSTAG stainless steel tag.



### Tamper-Proof Capability

The instrument can be made tamper-proof by inserting a wire through the built-in loop on the base of the enclosure and a hole in the lid of the enclosure and securing this wire with a lead seal.



### Rotatable Display Module

The display module can be rotated in 90° increments providing added mounting flexibility. Plus the various conduit connections allow a variety of installation options.



### Wide Viewing Angle

The window and display module have been optimized to provide a wide viewing angle of approximately ±40°; nearly twice that of the competition.



### Easy Wiring & Service

Both ProtEX+ and VantageView+ have been designed for easy wiring and servicing. All connections are made to removable screw terminal blocks. There are no exposed printed circuit boards. The display module snaps into the built-in rails on the enclosure ensuring a secure and perfect fit every time. No tools are needed to install or remove it. The options module is screwed into the base of the enclosure. Both modules completely encase the printed circuit boards.



Options Board (Left) and Display Module (Right)

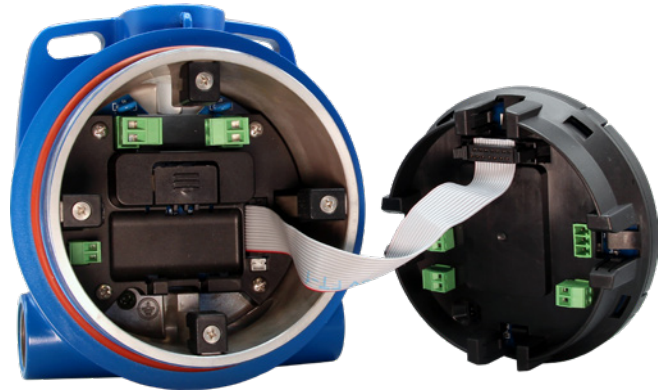

Options Board Connected to Display Module

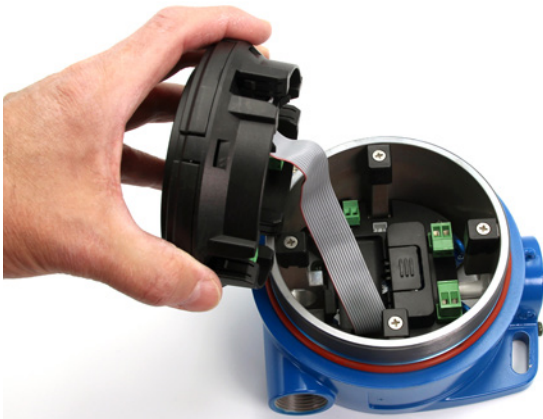

Options Board Mounted on the Bottom of Enclosure



Display Module Mounted on Built-In Rails

### USB Port for Easy Connection to Free MeterView XL Software



### Two Threaded Conduit Openings

The ProtEX+ comes with two 3/4" NPT threaded conduit openings as standard. It also available with M20 conduit openings as an option. The VantageView+ comes with three 3/4" NPT threaded conduit openings and two conduit plugs included.





## OPERATIONAL FEATURES

There are two ways the user can interact with the ProtEX+ and VantageView+ to perform a variety of useful functions: programmable function keys and the digital input.

### Programmable Function Keys

The three CapTouch buttons labeled F1, F2, and F3 can be programmed as function keys to perform a variety of meter functions simply by pressing on the window over the button. These include resetting the total, operating the batch control functions, resetting the meter's relays or open collectors, starting and stopping timers, and displaying max/min values. The default settings for the function keys are:

Button	Description (Default Settings)
	Press to display grand total. Continue pressing to cycle through max, min, rate, and total displays.
	Press to access the Reset menu. Press F1 to scroll through the options. Press F3 to reset the currently displayed parameter.
	Press to acknowledge all manually resettable relays or open collectors. Press to lock/unlock the display value after pressing the F1 key.

For a complete list of Function Keys settings, see *Function Keys & Digital Input Available Settings* on the next page.

### On-Board Digital Input

A digital input is standard on both ProtEX+ and VantageView+ meters. This digital input is programmed identically to the function keys. The input is triggered with a contact closure between DI+ and DI-, or with an active low signal. For a complete list of Digital Input settings, see *Function Keys & Digital Input Available Settings* on the next page.

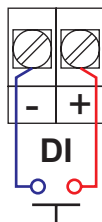

### Remote Operation of VantageView+

The VantageView+ digital input can be connected to a [PDA2360](#) single button remote control station as illustrated below and be programmed to perform various functions. Common uses for this digital input would be for resetting the total, operating the batch control functions, resetting the meter's relays or open collectors, starting and stopping timers, and displaying max/min values. For a complete list of Digital Input settings, see *Function Keys & Digital Input Available Settings* on the next page.

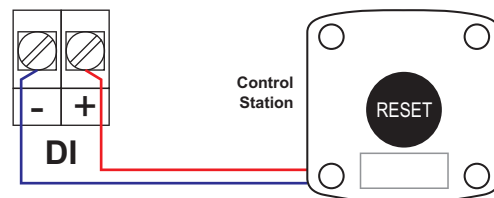

### Available Single Button Control Stations



PDA2360-E



PDA2361-A



PDA2361-B



PDA2361-R



PDA2361-T



PDA2361-S



PDA2361-Q

#### WARNING

- Control Stations do not carry hazardous area approvals and are thus not suitable for location in hazardous areas.

### Function Keys & Digital Input Available Settings

The following table describes the actions that the ProtEX+ and VantageView+ function keys and digital input can perform.

Display	Description
DISP FN	Set the function key or digital input to display a value
DISPLAY	Cycle max, min, rate, total, and grand total
R RATE	Display the rate
T TOTAL	Display the Total
DISP GT	Display the Grand Total
PCTRATE	Display the rate's percentage of max (20 mA)
U UNITS	Display rate, total, and grand total units
T TAG	Display the tags
DISPMIN	Display the minimum rate value
DISPMAX	Display the maximum rate value
MIN MAX	Display the minimum and maximum rate value
I mA IN	Display the mA input value
O mA OUT	Display the mA output value
MENU FN	Set the function key or digital input to access a menu
R RLYINFO	Go to relay information menu (INFO)
M MANCTRL	Go to output control menu (CONTROL)
T TIMR OC1	Open collector 1 timer
T TIMR OC2	Open collector 2 timer
T TIMER R1	Relay 1 timer
T TIMER R2	Relay 2 timer
TIMERFN	Set the function key or digital input to start or stop a timer
S STARTALL	Start all timers
S STOPALL	Stop all timers
S SSTOPALL	Start or stop all timers
O OC1	Start/stop open collector 1 timer
O OC2	Start/stop open collector 2 timer
R RLY1	Start/stop relay 1 timer
R RLY2	Start/stop relay 2 timer
S START	Start the selected timer output
S STOP	Stop the selected timer output
S STR--STP	Start or stop the selected timer output

Display	Description
BATCHFN	Set the function key or digital input to batch control
S START	Start a batch
S STOP	Stop a batch
S STR--STP	Start or stop
S PRESET	Preset batch amount
ALARMFN	Set the function key or digital input to acknowledge an alarm
S ACK	Acknowledge all active alarms
S SETPOINT	Set all output set point
S SETPTOC1	Set open collector 1 set point
S SETPTOC2	Set open collector 2 set point
S SETPTR1	Set relay 1 set point
S SETPTR2	Set relay 2 set point
SWATCHFN	Set the function key or digital input to activate stopwatch
S START	Start the stopwatch
S STOP	Pause/Stop the stopwatch
S STR--STP	Start or stop the stopwatch
HOLD FN	Set the function key or digital input to hold an output
S HOLDOUT	Hold all outputs
S HOLDUNHOLD	Hold or un-hold all outputs
S OC1+2	Hold/un-hold open collector outputs
S RLY1+2	Hold/un-hold relay outputs
S mAOUT	Hold/un-hold 4-20 mA output
S HOLD	Hold selected output
S HOLDUNHOLD	Hold or un-hold selected output
DISABLE	Disable the function key or digital input
RST FN	Set the function key or digital input to reset a value
S RESET	Reset min, max, or max/min PV value
S R MINMAX	Reset max and min PV value

## METERVIEW XL PROGRAMMING SOFTWARE

Free, PC-based, MeterView XL software that connects to the meter via a micro USB cable is available for programming and setup of the meters. This software greatly simplifies the programming process and also allows the user to save configuration files for later use. The meter will also be powered by the USB connection so no additional power is needed during programming.

For more information visit [www.predig.com/meterviewxl](http://www.predig.com/meterviewxl)



### WARNING

- The meter should only be connected to a computer while it is located in a safe area.

### Main Screen

The main screen displays an image of the connected meter and includes various information about this meter, such as model number, readings, and status.

### Input/Scale

The Input/Scale window is used to set the input, scale the input, and enable/disable the dual-scale feature.

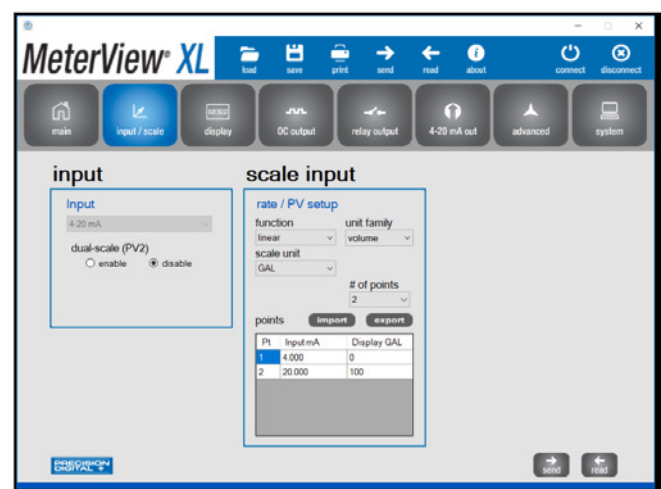

### Relay Output

The Relay Output window is used to assign a specific task to the 2 relays such as alarm, batch control, sample, timer, stopwatch, or off. A custom message that flashes every 10 seconds can also be added.

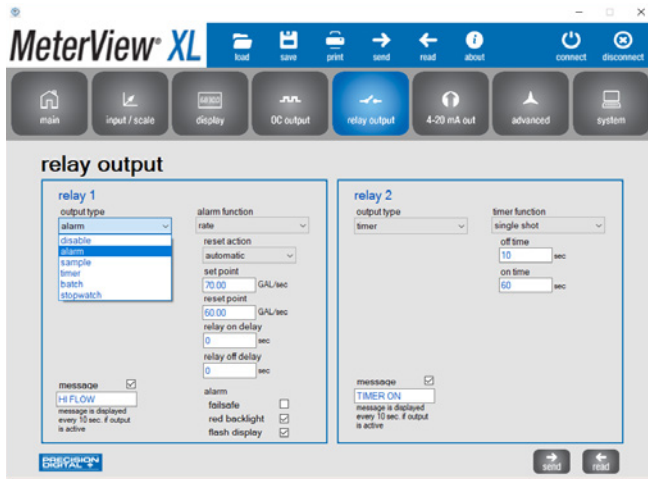

### 4-20 mA Output

The 4-20 mA Output window is used to program the isolated 4-20 mA output's source, range, and under and over range values.

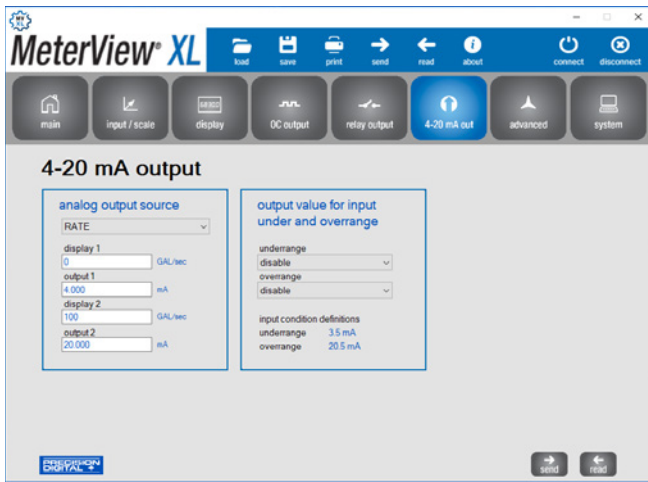

### Data Logging

MeterView XL software, when connected to the meter, can generate a log file such as the following example.

Date & Time	rate	units	grand total units
2/22/2021 12:51	4.67	GAL/sec	20 GAL
2/22/2021 12:52	7.32	GAL/sec	119 GAL
2/22/2021 12:52	9.94	GAL/sec	262 GAL
2/22/2021 12:52	12.68	GAL/sec	455 GAL
2/22/2021 12:52	15.34	GAL/sec	687 GAL
2/22/2021 12:53	18.01	GAL/sec	963 GAL
2/22/2021 12:53	20.67	GAL/sec	1283 GAL
2/22/2021 12:53	23.3	GAL/sec	1646 GAL
2/22/2021 12:54	25.95	GAL/sec	2053 GAL
2/22/2021 12:54	28.59	GAL/sec	2504 GAL
2/22/2021 12:54	31.37	GAL/sec	3014 GAL
2/22/2021 12:54	34.04	GAL/sec	3555 GAL
2/22/2021 12:55	36.68	GAL/sec	4139 GAL
2/22/2021 12:55	39.3	GAL/sec	4766 GAL
2/22/2021 12:55	42.05	GAL/sec	5458 GAL
2/22/2021 12:56	44.75	GAL/sec	6175 GAL
2/22/2021 12:56	47.4	GAL/sec	6936 GAL
2/22/2021 12:56	50.06	GAL/sec	7740 GAL
2/22/2021 12:56	52.67	GAL/sec	8588 GAL
2/22/2021 12:57	55.39	GAL/sec	9508 GAL
2/22/2021 12:57	58.08	GAL/sec	10445 GAL
2/22/2021 12:57	60.74	GAL/sec	11425 GAL
2/22/2021 12:57	63.38	GAL/sec	12450 GAL
2/22/2021 12:58	66.11	GAL/sec	13551 GAL
2/22/2021 12:58	68.75	GAL/sec	14664 GAL
2/22/2021 12:58	71.4	GAL/sec	15821 GAL
2/22/2021 12:59	74.08	GAL/sec	17022 GAL

### Configuration Files

A configuration file can be generated with or without a meter connected to the PC. This makes it possible to prepare meter configurations prior to having the meter in hand. Meter configurations can be saved and re-loaded into other meters. Meter configurations can also be printed.

**ACCESSORIES**

**PDA6846 2" U-Bolt Kits**



The PDA6846 U-Bolt Kits provide a convenient way to mount the meter to 1.5" or 2" pipes. They are available in steel and stainless steel.

Model	Description
<a href="#">PDA6846</a>	2" Zinc Plated Steel U-Bolt Kit with One U-Bolt
<a href="#">PDA6846-SS</a>	2" Stainless Steel U-Bolt Kit with One U-Bolt

**PDA-SSTAG Stainless Steel Tag**



The PDA-SSTAG is a laser etched stainless steel tag that can be customized with three lines of text. Each tag comes with a stainless steel wire and lead seal for easy mounting wherever you need.

Model	Description
<a href="#">PDA-SSTAG</a>	Stainless Steel Tag

**24 VDC Transmitter Power Supply**



The [PDA1024-01](#) 24 VDC power supply can be used for a variety of functions like powering 4-20 mA transmitters. It can be mounted on a [PDA1002](#) DIN rail.

Model	Description
<a href="#">PDA1024-01</a>	24 VDC Transmitter Power Supply
<a href="#">PDA1002</a>	6" DIN Rail Mounting Kit

**Specifications**

<b>Input Voltage</b>	85-264 VAC; 120-370 VDC
<b>Output Voltage</b>	21.6-29 VDC; 1.5 A rated current.
<b>Input Frequency</b>	47-63 Hz
<b>AC Current</b>	115 VAC: 0.88 A; 230 VAC: 0.48 A
<b>Connections</b>	Screw terminals
<b>Overload Protection</b>	105-160% rated output power. Constant current limiting, recovers automatically after fault condition is removed
<b>Operating Temperature</b>	-30 to 60°C (-22 to 140°F)
<b>Vibration</b>	10-500 Hz, 2G 10 min./1 cycle, period for 60 min. each along X, Y, Z axes
<b>Safety Standards</b>	UL 508 Listed and UL Recognized Component
<b>Dimensions</b>	1.40" x 3.50" x 2.10" (35 mm x 90 mm x 54.5 mm) (W x H x D)
<b>Warranty</b>	1 year parts & labor

**WARNING**

- PDA1024-01 does not carry hazardous area approvals and is thus not suitable for location in hazardous areas. The use of additional protective devices may allow it to be installed in a safe area and connected to a device in a hazardous area. User should consult a professional engineer to determine suitability of these products for their specific application.

Plugs



PDAPLUG75 3/4" NPT 316 stainless steel stopping plug with approvals is available for ProtEX+ meters. PDAPLUG75P 3/4" NPT plastic conduit plug is available for VantageView+ meters.

Model	Description
<a href="#">PDAPLUG75</a>	3/4" NPT 316 Stainless Steel Stopping Plug with Approvals for ProtEX+
<a href="#">PDAPLUG75P</a>	3/4" NPT Plastic Conduit Plug for VantageView+

Reducers



The following reducers are available for ProtEX+ meter.

Model	Description
<a href="#">PDAREDUCER-75M-50F</a>	M-3/4" NPT to F-1/2" NPT Reducer with Approvals
<a href="#">PDAREDUCER-75M-M20F</a>	M-3/4" NPT to F-M20 Reducer with Approvals

Plastic Control Stations

The PDA2360 series of plastic control stations provide a convenient way to remotely control devices. The VantageView+ digital input can be wired to any of the following control stations to perform a single task.

Model	Description
<a href="#">PDA2360-E</a>	Emergency Button
<a href="#">PDA2361-A</a>	Ack Button
<a href="#">PDA2361-B</a>	Blank Button
<a href="#">PDA2361-R</a>	Reset Button
<a href="#">PDA2361-T</a>	Tare Button
<a href="#">PDA2361-S</a>	Stop Button
<a href="#">PDA2361-Q</a>	Silence Button

Notes:

- Control stations can be connected directly to the meter's Digital Input terminals labeled DI+ and DI-.



**⚠ WARNING**

- Control Stations do not carry hazardous area approvals and are thus not suitable for location in hazardous areas. The use of additional protective devices may allow them to be installed in a safe area and connected to a device in a hazardous area. User should consult a professional engineer to determine suitability of these products for their specific application.



**PD9501 Multi-Function Calibrator**



This PD9501 Multi-Function Calibrator has a variety of signal measurement and output functions, including voltage, current, thermocouple, and RTD.

Model	Description
<a href="#">PD9501</a>	Multi-Function Calibrator

**Signal Splitter & Conditioner Accessories**



The PD659 series includes DIN rail mountable models for signal isolation, splitting and conditioning of 4-20 mA and 0-10 VDC signals.

Model	Description
<a href="#">PD659-1MA-1MA</a>	Signal Isolator with One 4-20 mA Input and One 4-20 mA Output
<a href="#">PD659-1MA-2MA</a>	Signal Splitter with One 4-20 mA Input and Two 4-20 mA Outputs
<a href="#">PD659-1V-1MA</a>	Signal Conditioner with One 0-10 VDC Input and One 4-20 mA Output
<a href="#">PD659-1MA-1V</a>	Signal Conditioner with One 4-20 mA Input and One 0-10 VDC Output

**PD9502 Low-Cost Signal Generator**



The PD9502 is a low-cost, compact, simple to use 4-20 mA or 0-10 VDC signal generator. It can easily be set for 0-20 mA, 4-20 mA, 0-10 V or 2-10 V ranges. Signal adjustment is made with a one-turn knob. A wall plug is provided with the instrument. Optional USB power bank is available.

Model	Description
<a href="#">PD9502</a>	Low-Cost Signal Generator
<a href="#">PDA1001</a>	USB Power Bank

**⚠ WARNING**

- These accessories do not carry hazardous area approvals and are thus not suitable for location in hazardous areas. The use of additional protective devices may allow them to be installed in a safe area and connected to a device in a hazardous area. User should consult a professional engineer to determine suitability of these products for their specific application.

# Complete Product Line of Loop-Powered Meters

## WITH ALL THE SAME FEATURES & FUNCTIONALITY



2 Open Collector  
Outputs



2 Solid-State  
Relays



4-20 mA  
Output



Two-Color  
Backlight

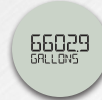

Dual-Line  
Displays



Pump  
Control



Batch  
Control



Ex CE IECEx

### LARGE DISPLAY ❖

#### PD4 Loop Leader+ Series

- NEMA 4X, IP65 Rated Wall-Mount Enclosures
- Large 5-Digit, 2.8" High Top Display
- Safe Area and I.S. Models
- ATEX and IECEx Certified



Ex CE IECEx

### EXPLOSION-PROOF ❖

#### PD6900 ProtEX+ Series

- NEMA 4X, IP68 Rated Aluminum and Stainless Steel Enclosures
- CapTouch Through-Glass Buttons
- Explosion-Proof & I.S.
- CSA, ATEX, and IECEx Certified



UL LISTED Ex CE IECEx

### 1/8 DIN PANEL MOUNT ❖

#### PD6600 Loop Leader Series

- NEMA 4X, IP65 Rated Front 1/8 DIN Panel Mount Meters
- General Purpose and I.S. and N.I. Models
- UL, C-UL, and CE Approved

VantageView+ CE

### FIELD-MOUNT ❖

#### PD6900 VantageView+ Series

- NEMA 4X, IP66 Rated Plastic Enclosure
- CapTouch Through-Window Buttons
- General Purpose



MeterView XL Software Programs All These Products

Go to [PREDIG.COM](http://PREDIG.COM) for details

**DIMENSIONS**

**ProtEX+**

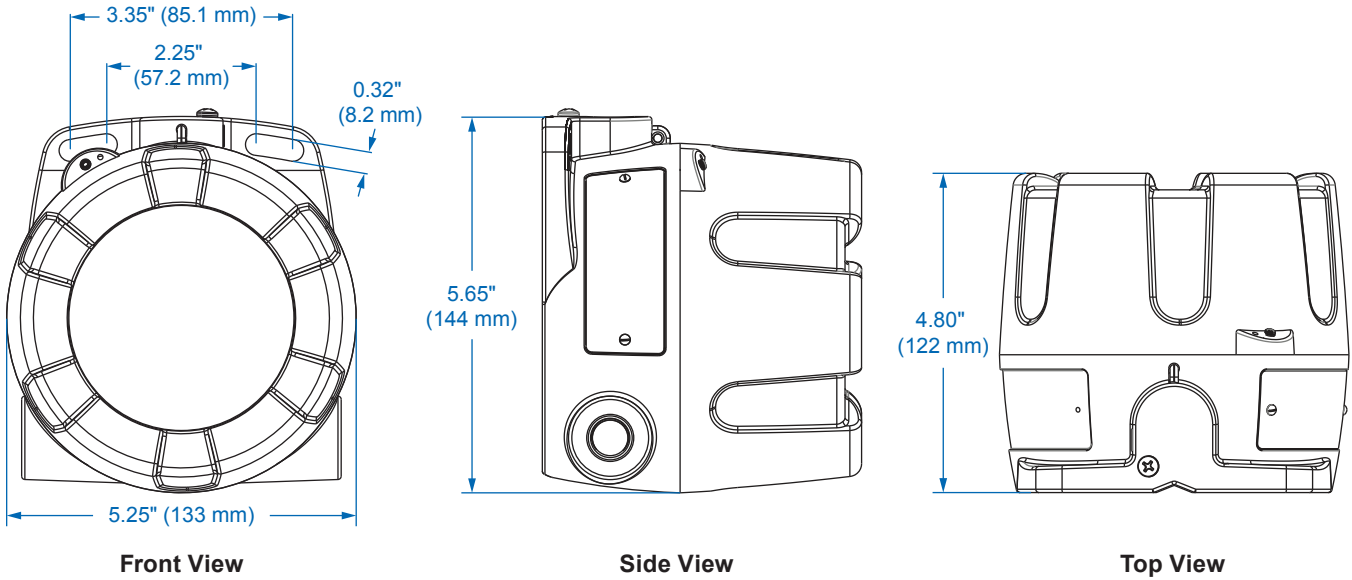

**VantageView+**

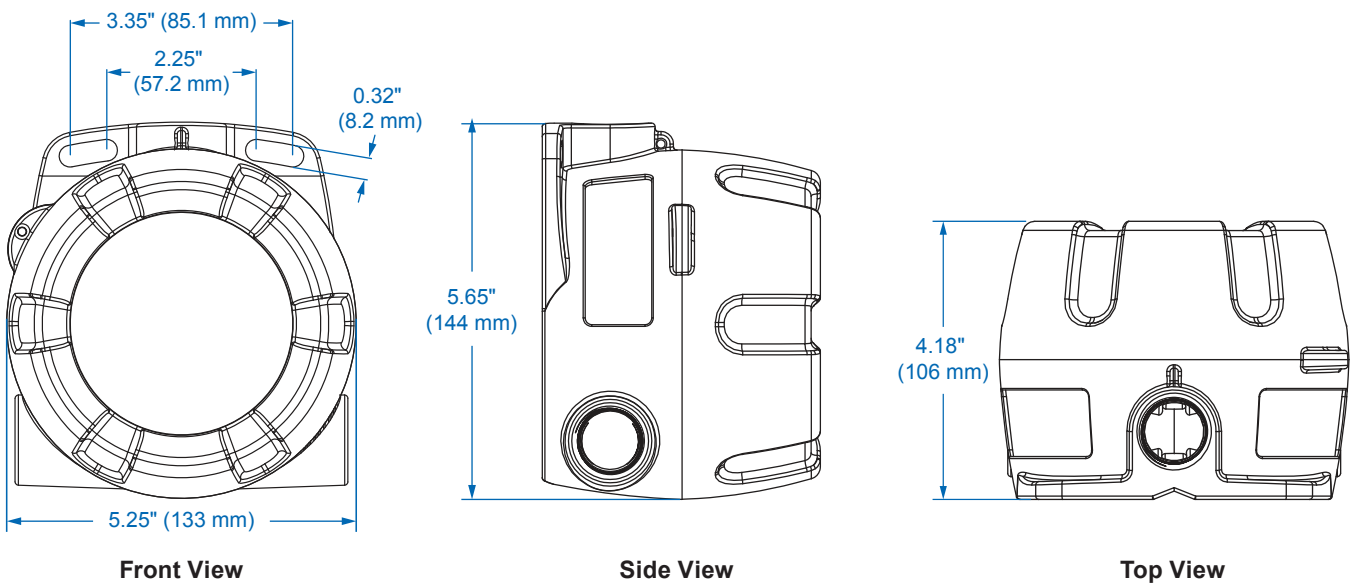

Download free 3-D CAD files of these instruments to simplify your drawings!

[predig.com/documentation-cad](http://predig.com/documentation-cad)

## CONNECTIONS

### Connectors Labeling

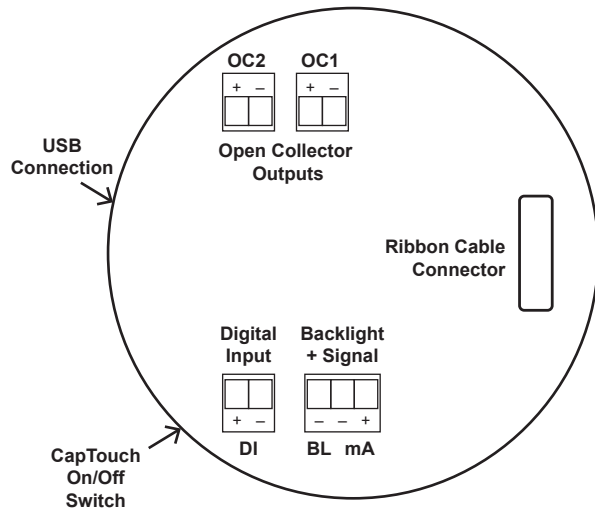

-LNN Base Meter (2 Open Collectors Standard)

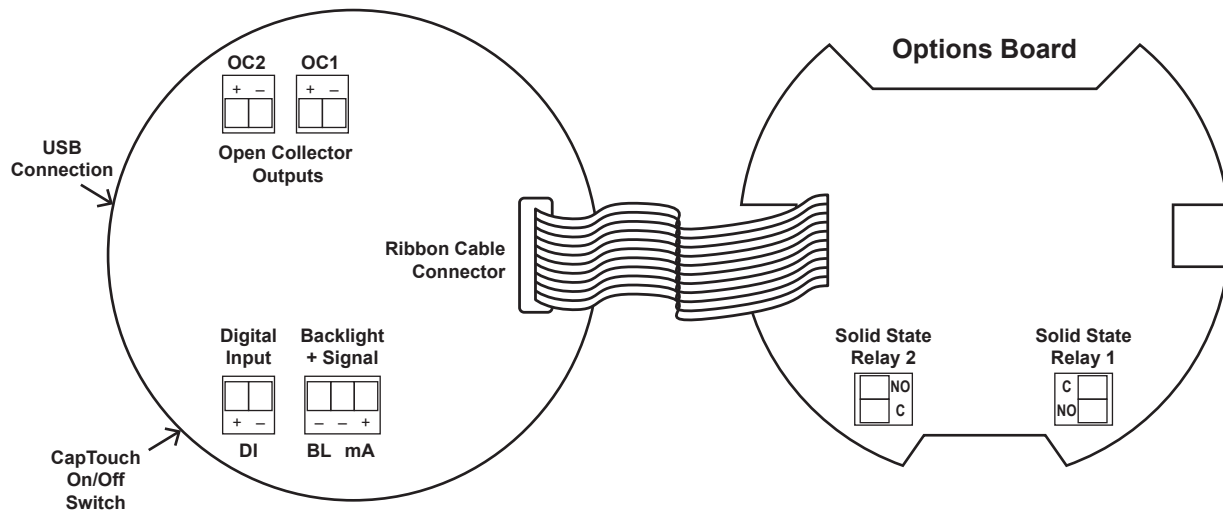

-L2N Option (2 Solid-State Relays)

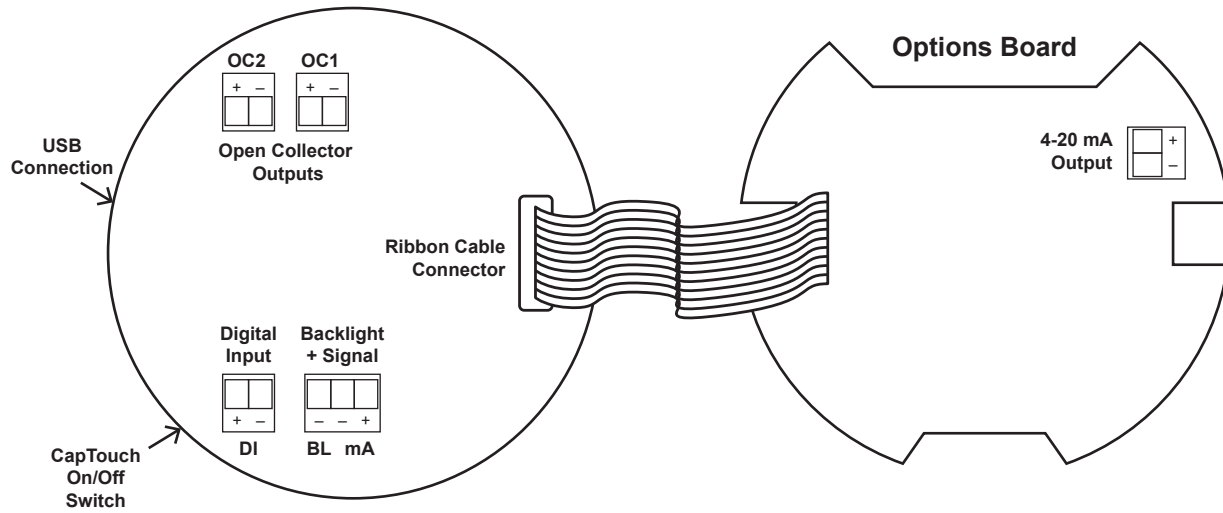

-L3N Option (4-20 mA Output)

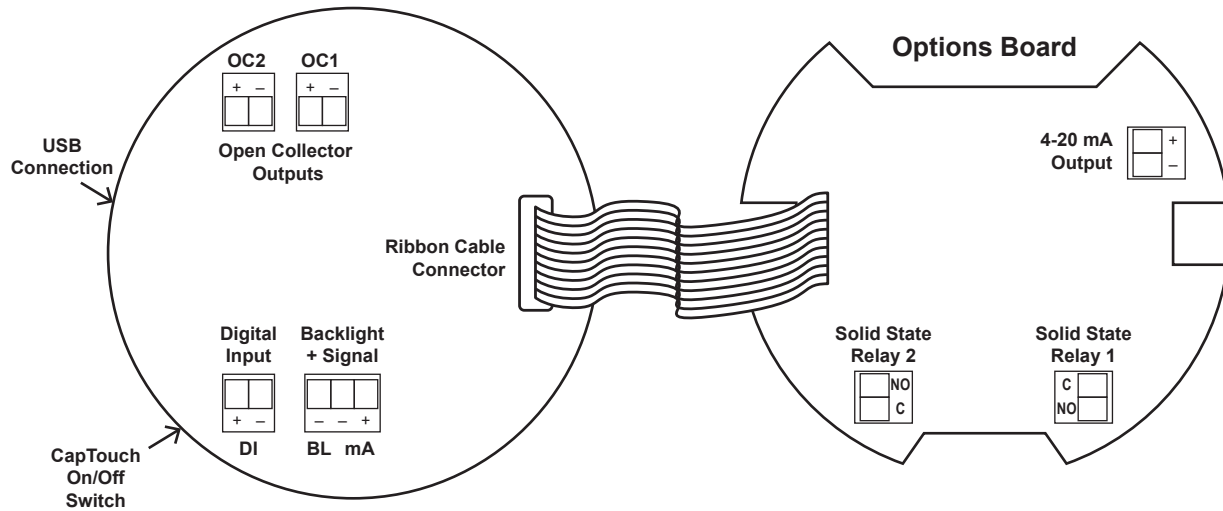

-L5N Option (2 Solid-State Relays and 4-20 mA Output)

## WIRING DIAGRAMS

For existing applications, one of the great benefits of loop-powered meters is that they get their power directly from the 4-20 mA loop and thus require no additional wiring. All a user has to do is break the existing loop and wire in the meter.

### ⚠ WARNING

- See Control Drawing [LIM6908-2](#) for information on hazardous area wiring.

### Input Loop (4-20 mA) Connections

The following figures show a 4-20 mA loop connected to the meter. The first figure shows the connection without the backlight and the second shows the connection with the backlight. The meter is powered by the 4-20 mA current loop.

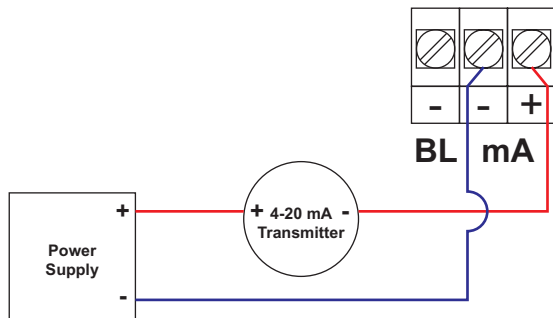

4-20 mA Input Connection without Backlight

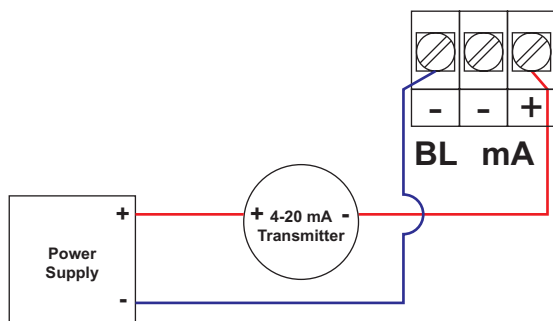

4-20 mA Input Connection with Backlight

### Digital Input Connections

A digital input is standard on the meter. This digital input is connected with a normally open contact across DI+ and DI-, or with an active low signal applied to DI+ and DI-.

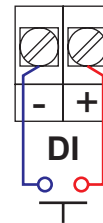

### 4-20 mA Output Connections

Connections for the 4-20 mA transmitter output are made to the connector terminals labeled mA OUT. The 4-20 mA output must be powered from an external power supply.

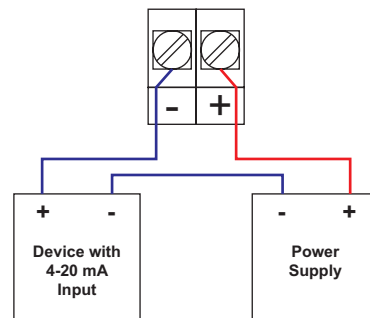

### Solid-State Relay Connections

Relay connections are made to two-terminal connectors. Each relay's C terminal is common only to the normally open (NO) contact of the corresponding relay.

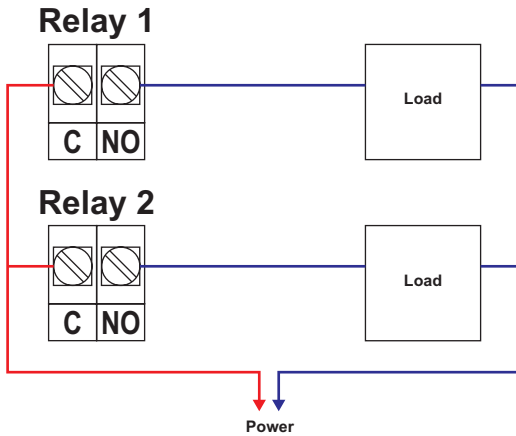

### Open Collector Outputs

Open collector output 1 and 2 connections are made to terminals labeled O1+ and O1-, and O2+ and O2-. Connect the alarm or pulse input device as shown below.

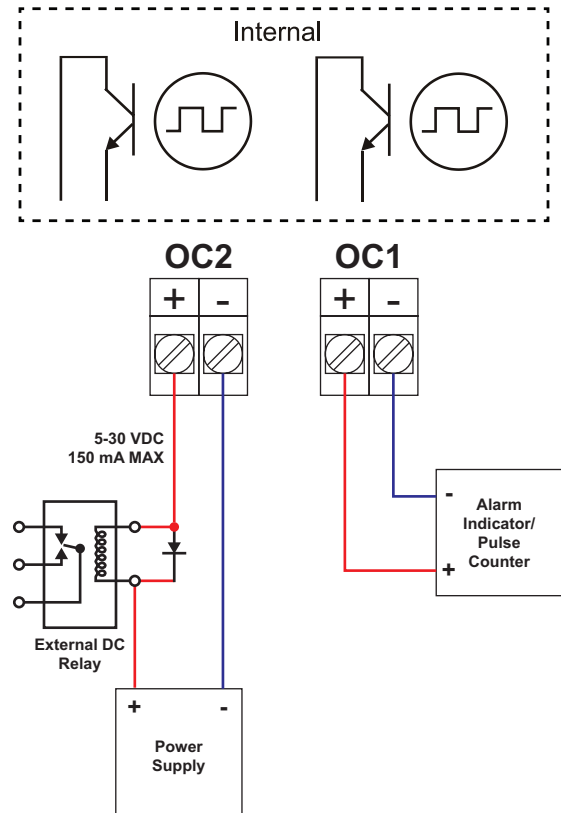

## SPECIFICATIONS

Except where noted all specifications apply to operation at +25°C.

### Display

<b>Display</b>	Dual-line LCD with backlight. Both lines alphanumeric. Top: 0.7" (17.8 mm) 5 digits, 12-segment Bottom: 0.4" (10.2 mm) 8 characters, 14-segment Display may be programmed to turn red and flash a user-defined message on alarm condition.
<b>Top Display</b>	5 digits (-9999 to 99999) or 5 characters (all capital & most lower-case letters)
<b>Bottom Display</b>	8 digits (-9,999,999 to 99,999,999; separated by commas) or 8 characters (all capital & most lower-case letters)
<b>Backlight</b>	Powered by 4-20 mA loop. Intensity varies with signal level.
<b>Bargraph</b>	20 segments Assignable to rate, total, or off Scale: 0 to 100%
<b>Decimal Point</b>	Up to four decimal places on top display and up to seven decimal places on bottom display
<b>Commas</b>	Commas to indicate 1000s (e.g. 88,987,628) on bottom display only
<b>Dual-Scale Feature</b>	If the totalizer is disabled, the input can be displayed in different scales on the top and bottom displays. For instance, the top display could display the flow in GPM and the bottom display could display that same input in CFM.
<b>Alarm Indication</b>	Programmable: loop-powered red backlight, flashing display, alarm symbol ▲, bargraph segment flashes on alarm.
<b>Custom Alarm Messages</b>	Programmable for each relay/open collector: 8 characters maximum; displayed every 10 sec for 1 sec on bottom display. May be turned off.
<b>Display Update Rate</b>	Ambient > -10°C: 1 Update/Second Ambient = -20°C: 1 Update/2 Seconds From -20°C to -40°C the update rate slows down 1 second for every -2°C (e.g. at -24°C, 1 update/4 seconds).
<b>Overrange</b>	Top: 99999; Bottom: 99,999,999 (flashing)
<b>Underrange</b>	Top: -99999; Bottom: -9,999,999 (flashing)

### General

<b>Programming Method</b>	Four CapTouch through-window buttons when cover is installed. The CapTouch buttons can be used with the cover removed. Free PC-based USB MeterView XL programming software.
<b>Environmental</b>	Operating temperature range: -40 to 75°C (-40 to 167°F) Storage temperature range: ProtEX+: -55 to 85°C (-67 to 185°F) VantageView+: -40 to 85°C (-40 to 185°F) Installation temperature range: ProtEX+: -55 to 75°C (-67 to 167°F) (The display ceases to function, however inputs and outputs continue to operate) VantageView+: -40 to 75°C (-40 to 167°F) Relative humidity: 0 to 90% non-condensing Printed circuit boards are conformally coated
<b>Noise Filter</b>	Averages the input signal over a period of time between 1 and 16 seconds to dampen the effects of a noisy signal that causes a jumpy display.
<b>Filter Bypass</b>	0.0 to 99.9% of full scale. Input signal changes greater than bypass value are displayed immediately.
<b>Recalibration</b>	Recalibration is recommended at least every 12 months.
<b>Max/Min Display</b>	Max/min readings reached by the process are stored until reset by the user or until power to the meter is turned off.
<b>Password</b>	The Main password prevents access to the meter Programming Mode.  Total and Grand Total passwords prevent resetting the total and grand total, respectively.
<b>Non-Volatile Memory</b>	Total and Grand Total values, and all programmed settings are stored in non-volatile memory for a minimum of ten years if power is lost.
<b>Normal Mode Rejection</b>	64 dB at 50/60 Hz
<b>Connections</b>	Removable screw terminal blocks Display terminals: accept 16 to 30 AWG wire Relay terminals: accept 12 to 26 AWG wire 4-20 mA output: accept 16 to 30 AWG wire
<b>Tightening Torque</b>	Display terminals: 2.5 lb-in (0.28 Nm) Relay terminals: 4.5 lb-in (0.5 Nm) 4-20 mA output terminals: 2.5 lb-in (0.28 Nm)
<b>Overall Dimensions</b>	ProtEX+: 5.25" x 5.65" x 4.80" (133 x 144 x 122 mm) (W x H x D)  VantageView+: 5.25" x 5.65" x 4.18" (133 x 144 x 106 mm) (W x H x D)
<b>Weight</b>	ProtEX+: Aluminum: 5.1 lbs (2.3 kg); Stainless Steel: 9.4 lbs (4.3 kg)  VantageView+: 1.9 lbs (0.9 kg)
<b>Warranty</b>	3 years parts and labor. See Warranty Information and Terms & Conditions on <a href="http://www.predig.com">www.predig.com</a> for complete details.



## Enclosure

<b>Material</b>	ProtEX+ -AL Models: ASTM A413 LM6 die-cast aluminum, copper-free, enamel coated  ProtEX+ -SS Models: ASTM A743 CF8M investment-cast 316 stainless steel  VantageView+ -PL Models: Polycarbonate plastic with UV stabilizer
<b>Gasket</b>	ProtEX+ Models: Fluoroelastomer  VantageView+ Models: Buna-N
<b>Rating</b>	-AL/-SS: NEMA 4X, IP68 Explosion-proof -PL: NEMA 4X, IP66 plastic, UL 94V-0
<b>Color</b>	-AL: Blue; -SS: Silver; -PL: Grey
<b>Window</b>	-AL/-SS: Borosilicate glass  -PL: Clear polycarbonate with UV stabilizer
<b>Conduits</b>	-AL/-SS: Two ¾" NPT threaded conduit openings. M20 conduits are available. See Ordering Information for details.  -PL: Three ¾" NPT threaded conduit openings
<b>Conduit Stopping Plug</b>	-AL/-SS: Sold separately  -PL: Two ¾" NPT plastic conduit plugs with 1.29" wrenching flats and a screwdriver slot are included
<b>Flange</b>	Built-in flange for wall and pipe mounting.
<b>Tamper-Proof Seal</b>	Cover may be secured with tamper-proof seal.
<b>Instrument Tag Loop</b>	Built-in loop for securing stainless steel tag
<b>ATEX &amp; IECEx (ProtEX+ enclosure only)</b>	Flameproof Ⓜ II 2GD Ex db IIC Gb Ex tb IIIC Db IP66/IP68 Tamb: -55°C to +85°C Certificate No.: Sira 19ATEX1252U Certificate No.: IECEx SIR 19.0075U
<b>CSA (ProtEX+ enclosure only)</b>	Class I, Division 1, Groups A, B, C, D Class II, Division 1, Group E, F, G Class III Ex db IIC Gb Ex tb IIIC Db Class I, Zone 1, AEx db IIC Gb Zone 21, AEx tb IIIC Db IP66/IP68/TYPE 4X Tamb: -55°C to +85°C Certificate No.: 80011200
<b>UL (ProtEX+ enclosure only)</b>	Class I, Division 1, Groups A, B, C, D Class II, Division 1, Groups E, F, G Class III Class I, Zone 1, AEx db IIC Gb Zone 21, AEx tb IIIC Ex db IIC Gb Ex tb IIIC Db IP66/IP68/TYPE 4X Tamb: -55°C to +85°C Certificate Number: E518920

**Note:** The above approvals are for the enclosure only. See *Compliance Information* for approvals on the entire instrument.

## Input

<b>Input</b>	4-20 mA
<b>Accuracy</b>	±0.02% of span ±1 count Square root and programmable exponent: 10-100% FS
<b>Voltage Drop</b>	Without Backlight: 1.5 V maximum, With backlight: 4.7 V maximum
<b>Equivalent Resistance</b>	With backlight off: 75 Ω @ 20 mA With backlight on: 235 Ω @ 20 mA
<b>Input Overload</b>	Over current protection to 1 A maximum Over voltage protection to 30 VDC max (between mA+ and mA-/BL-)
<b>Temperature Drift</b>	25 PPM/°C from -40 to 75°C ambient
<b>Function</b>	Rate: Linear (2-32 points), square root, or programmable exponent. If the totalizer is disabled, PV1 and PV2: Linear (2-32 points) or round horizontal tank
<b>Low-Flow / Cutoff</b>	Point below at which the display always shows zero. 0.1 to 999,999 or disable.
<b>HART Transparency</b>	The meter does not interfere with existing HART communications; it displays the 4-20 mA primary variable and it allows the HART communications to pass through without interruption. The meter is not affected if a HART communicator is connected to the loop. The meter does not display secondary HART variables.

## MeterView XL

<b>Availability</b>	Free download from <a href="http://www.predig.com">www.predig.com</a>
<b>System Requirements</b>	Microsoft® Windows® 7 & 10
<b>Communications</b>	USB 2.0 (Standard USB A to Micro USB B) Cable provided
<b>Configuration</b>	Configure all parameters on the meter. Configure meters one at a time.
<b>Configuration Files</b>	Generate with or without meter connected; Save to file for later use.
<b>USB Power Connection</b>	Meter is powered by USB connection during programming, if 4-20 mA loop is not connected.

### WARNING

- The meter should only be connected to a computer while it is located in a safe area.

<b>Compatibility</b>	Programs created for Loop Leader and Loop Leader+ may be run on either meter. Programs created for VantageView+ and ProtEX+ can be run on either meter. No other program sharing is permissible.
----------------------	--

### Batch Control

<b>Methods</b>	Automatic or Manual, count up or count down
<b>Manual Batch Start</b>	Pressing F1 function key starts the batch
<b>Manual Batch Pause/Stop</b>	Pressing F3 once pauses the batch, pressing it twice cancels the batch
<b>Automatic Batching</b>	The PD6928 can be used as an automatic batch controller where batches run continuously without operator input
<b>Batching Relay Operation</b>	Single or dual-relay batching with optional preclose for two-stage operation
<b>Batch Preset</b>	Set via F2 function key anywhere between 0.0001 to 99,999 based on batch total decimal point. If batch total is assigned to bottom, the preset can be up to 8 digits.
<b>Batch Preclose</b>	For two-stage batch application, a preclose value can be set to close the main flow line.
<b>Automatic Batch Restart Delay</b>	1 to 9,999 seconds. The batch will automatically restart after completion of the last batch.

### Rate/Totalizer

<b>Rate Display</b>	Top display: -9999 to 99999; Bottom display: -9,999,999 to 99,999,999 (with commas)
<b>Total &amp; Grand Total Display</b>	Top display: 0 to 999999; Bottom display: 0 to 99,999,999 (with commas)
<b>13-Digit Total &amp; Grand Total</b>	Up to 9,999,999,999,999 using both lines with 13-digit total feature enabled.
<b>Total &amp; Grand Total Indication</b>	On bottom display, "T" indicates total and "GT" indicates grand total
<b>Total Decimal Point</b>	Up to four decimal places on top, up to seven decimal places on bottom. Total decimal point is independent of rate decimal point.
<b>Totalizer</b>	Calculates total based on rate and rate units to display total in engineering units. A custom factor must be programmed if using custom defined units.
<b>Time Base</b>	Seconds, Minutes, Hours, Days
<b>Totalizer Rollover</b>	Totalizer rolls over when display exceeds 99,999,999 (9,999,999,999,999 if 13-digit limit enabled). Relay status reflects display.
<b>Total &amp; Grand Total Reset</b>	Via CapTouch button, external contact closure on digital input, or MeterView XL.
<b>Total &amp; Grand Total Reset Passwords</b>	Total and grand total passwords may be entered to prevent resetting the total or grand total unless a password is entered.
<b>Non-Resetable Grand Total</b>	Grand total reset may be disabled through the meter interface. Grand total reset may be permanently disabled by selecting $\nabla$ ES at the PERMLOCK menu.
<b>CAUTION</b>	
• Once the Grand Total has been programmed as "non-resettable" the feature cannot be disabled.	
<b>Non-Volatile Memory</b>	Total and Grand Total values are stored in non-volatile memory for a minimum of ten years if power is lost.

### Common Open Collector & Relay Specifications

<b>Number</b>	Two open collectors & two relays
<b>High or Low Alarm</b>	User programmable for high or low alarm
<b>Alarm Deadband</b>	0-100% FS, user programmable
<b>Output Assignment</b>	Alarm, Timer, Stopwatch, or Disable
<b>Alarm Output Source</b>	Assign to rate, total, grand total, or digital input
<b>On &amp; Off Time Delay</b>	0 to 9,999 seconds
<b>Fail-Safe Operation</b>	Independent for each open collector and relay. Fail-safe on, the output is on under normal conditions. Fail-safe off, the output is on under alarm conditions.
<b>Alarm Operation</b>	Automatic, automatic with manual override, latching (manual reset anytime), latching with reset after cleared (manual reset only after alarm has cleared)
<b>Alarm Indication</b>	Programmable: loop-powered red backlight, flashing display, alarm symbol ▲, bargraph segment flashes on alarm.
<b>Custom Alarm Messages</b>	Programmable for each relay/open collector: 8 characters maximum; displayed every 10 sec for 1 sec on bottom display. May be turned off.
<b>Alarm Acknowledge</b>	CapTouch ACK button or external digital input resets output and screen indication.
<b>Auto Initialization</b>	When power is applied to the meter, open collectors and relays will reflect the state of the input to the meter.
<b>Timer Output</b>	One-shot or Continuous Off Time Delay: 1 sec to 99:59:59 (hrs:min:sec) On Time: 1 sec to 99:59:59 (hrs:min:sec)
<b>Stopwatch</b>	Output turns on when started and off when stopped.

### Open Collector Outputs

<b>Rating</b>	Isolated open collector, sinking NPN 5-30 VDC @ 150 mA maximum
<b>Output Assignment</b>	Pulse, Alarm, Timer, Stopwatch on/off, or Disable
<b>Pulse Output Source</b>	Pulse output based on Rate, Total, Grand Total, or Test Frequency, Alarm, Timer, Total Reset, Stopwatch on/off, or Disable
<b>Pulse Output Factor</b>	0.000001 to 999,999.9
<b>Pulse Width</b>	0.5 ms @ 1 kHz; 500 ms @ 1 Hz; 50% duty cycle
<b>Pulse Output Frequency</b>	1,000 Hz maximum
<b>Quadrature Pulse Output</b>	Available for Output 2 (90° behind Output 1) 500 Hz maximum
<b>Alarm Output Source</b>	Assign to Rate, Total, Grand Total or Digital Input

### Solid-State Relays

<b>Rating</b>	250 VAC/VDC @ 0.5 A resistive 38 VA; 250 VAC; 0.3 A pilot duty (inductive) 13 VA; 250 VDC; 0.3 A pilot duty (inductive)
<b>Noise Suppression</b>	Metal oxide varistors across outputs
<b>Relay Assignment</b>	Alarm, Sample, Timer, Batch, Stopwatch on/off, or Disable
<b>Alarm Output Source</b>	Assign to Rate, Total, Grand Total, or Digital Input
<b>Relay Runtime</b>	Meter will keep track of how long each relay has operated and display this information.
<b>Relay Cycles</b>	Meter will keep track of how many times the relays have cycled and display this information.

### 4-20 mA Transmitter Output (Passive)

<b>Accuracy</b>	±0.05% FS ±0.001mA
<b>Output Source</b>	Rate, total, re-transmit; reverse scaling allowed
<b>Scaling Range</b>	1.00 to 23.0 mA
<b>Disable</b>	High impedance state, less than 1 mA
<b>Calibration</b>	Factory calibrated 4.00 to 20.00 mA
<b>Underrange</b>	1.0 mA, 3.5 mA, or 3.8 mA (If input < 3.5 mA); or Off; user selectable
<b>Overrange</b>	20.5 mA, 20.8 mA, or 23.0 mA (If input > 20.5 mA); or Off; user selectable
<b>Isolation</b>	500 V input-to-output
<b>Temperature Drift</b>	0.5 µA/°C max from -40 to 75°C ambient
<b>External Loop Power Supply</b>	7.0 VDC to 30.0 VDC maximum
<b>Output Loop Resistance</b>	10-750 Ω @ 24 VDC; 10-1100 Ω @ 30 VDC

### On-Board Digital Input

<b>Function</b>	Remote operation of front-panel buttons, acknowledge/reset relays, reset total, reset max/min values, <a href="#">start/stop batch</a> , etc.
<b>Contacts</b>	2.1 VDC on contact. Connect normally open contacts across DI+ and DI-
<b>Logic Levels</b>	Logic High: 2.4 to 30 VDC (max) Logic Low: 0 to 0.9 VDC

### General Compliance Information

#### Electromagnetic Compatibility

- EMC Emissions**
- CFR 47 FCC Part 15 Subpart B Class A emissions requirements (USA)
  - ICES-003 Information Technology emissions requirements (Canada)
  - AS/NZS CISPR 11 Group 1 Class A ISM emissions requirements (Australia/New Zealand)
  - EN 55011 Group 1 Class A ISM emissions requirements (EU)
  - EN 61000-6-4 Emissions requirements for Heavy Industrial Environments - Generic

**EMC Emissions and Immunity** EN 61326-1 EMC requirements for Electrical equipment for measurement, control, and laboratory use – industrial use

#### Compliance Information (ProtEX+ Only)

#### Hazardous Area Approvals

**CSA** Explosion-proof for use in: Class I, Division 1, Groups B, C and D  
Dust-ignition proof for use in: Class II/III, Division 1, Groups E, F and G; T6  
Flame-proof for use in: Zone 1, Ex d IIC T6  
Ta = -55 to 75°C.  
Enclosure: Type 4X & IP66/IP68.  
Certificate number: 2325749

**ATEX** Intrinsically safe for use in:  
Ⓢ II 1 G D  
Ex ia IIC T4 Ga  
Ex ia IIIC T200°C Da  
Ta = -55 to 75°C  
Enclosure: Type 4X & IP66/IP68  
Install per Control Drawing DW2636 (contained within [LIM6908-2](#))  
Certificate number: CML 18ATEX2089X

Explosion-proof for use in:  
Ⓢ II 2 G D  
Ex db IIC T6 Gb  
Ex tb IIIC T85°C Db IP68  
Ta = -55 to 75°C  
Certificate number: Sira 10ATEX1116X

**IECEX** Intrinsically safe for use in:  
Ex ia IIC T4 Ga  
Ex ia IIIC T200°C Da  
Ta = -55 to 75°C  
Enclosure: Type 4X & IP66/IP68  
Install per Control Drawing DW2636 (contained within [LIM6908-2](#))  
Certificate number: IECEX CML 18.0050X

Explosion-proof for use in:  
Ex db IIC T6 Gb  
Ex tb IIIC T85°C Db IP68  
Ta = -55 to 75°C  
Certificate number: IECEX SIR 10.0056X

**ORDERING INFORMATION**

**General Purpose Instruments**

VantageView+ PD6928 • Flow Rate/Totalizer Plastic Enclosure	
Model	Description
PD6928-GP-PL-LNN	Loop-Powered Field-Mount Flow Rate/Totalizer, No Options
PD6928-GP-PL-L2N	Loop-Powered Field-Mount Flow Rate/Totalizer, Two Solid-State Relays
PD6928-GP-PL-L3N	Loop-Powered Field-Mount Flow Rate/Totalizer, 4-20 mA Analog Output
PD6928-GP-PL-L5N	Loop-Powered Field-Mount Flow Rate/Totalizer, Two Solid-State Relays & 4-20 mA Analog Output

**Notes:**

1. All VantageView+ models come with bargraph, two open collector outputs, and one digital input standard.
2. The VantageView+ comes standard with three 3/4" NPT conduit openings and two plastic plugs.

**Hazardous Area Instruments**

ProtEX+ PD6928 • Flow Rate/Totalizer Aluminum Enclosure	
Model	Description
PD6928-HA-AL-LNN	Loop-Powered Explosion-Proof & Intrinsically Safe Flow Rate/Totalizer, No Options
PD6928-HA-AL-L2N	Loop-Powered Explosion-Proof & Intrinsically Safe Flow Rate/Totalizer, Two Solid-State Relays
PD6928-HA-AL-L3N	Loop-Powered Explosion-Proof & Intrinsically Safe Flow Rate/Totalizer, 4-20 mA Analog Output
PD6928-HA-AL-L5N	Loop-Powered Explosion-Proof & Intrinsically Safe Flow Rate/Totalizer, Two Solid-State Relays & 4-20 mA Analog Output

ProtEX+ PD6928 • Flow Rate/Totalizer Stainless Steel Enclosure	
Model	Description
PD6928-HA-SS-LNN	Loop-Powered Explosion-Proof & Intrinsically Safe Flow Rate/Totalizer, No Options
PD6928-HA-SS-L2N	Loop-Powered Explosion-Proof & Intrinsically Safe Flow Rate/Totalizer, Two Solid-State Relays
PD6928-HA-SS-L3N	Loop-Powered Explosion-Proof & Intrinsically Safe Flow Rate/Totalizer, 4-20 mA Analog Output
PD6928-HA-SS-L5N	Loop-Powered Explosion-Proof & Intrinsically Safe Flow Rate/Totalizer, Two Solid-State Relays & 4-20 mA Analog Output

**Notes:**

1. All ProtEX+ models come with bargraph, two open collector outputs, and one digital input standard.
2. The ProtEX+ comes standard with two 3/4" NPT conduit holes. To order models with M20 conduit holes instead, add -21 at the end of the part number (e.g. PD6907-HA-AL-LNN-21).

## Accessories

General Accessories	
Model	Description
<a href="#">PD659-1MA-1MA</a>	Signal Isolator with One 4-20 mA Input and One 4-20 mA Output
<a href="#">PD659-1MA-2MA</a>	Signal Splitter with One 4-20 mA Input and Two 4-20 mA Outputs
<a href="#">PD659-1V-1MA</a>	Signal Conditioner with One 0-10 VDC Input and One 4-20 mA Output
<a href="#">PD659-1MA-1V</a>	Signal Conditioner with One 4-20 mA Input and One 0-10 VDC Output
<a href="#">PD9501</a>	Multi-Function Calibrator
<a href="#">PD9502</a>	Low-Cost Signal Generator
<a href="#">PDA1002</a>	6" DIN Rail Mounting Kit
<a href="#">PDA1024-01</a>	24 VDC Power Supply for DIN Rail
<a href="#">PDAPLUG75</a>	3/4" NPT 316 SS Conduit Plug with Approvals
<a href="#">PDAPLUG75P</a>	3/4" NPT Plastic Conduit Plug
<a href="#">PDAREDUCER-75M-50F</a>	M-3/4" NPT to F-1/2" NPT Reducer with Approvals
<a href="#">PDAREDUCER-75M-M20F</a>	M-3/4" NPT to F-M20 Reducer with Approvals
<a href="#">PDA-SSTAG</a>	Stainless Steel Tag

PDA2360 Series Control Stations	
Model	Description
<a href="#">PDA2360-E</a>	Emergency Button
<a href="#">PDA2361-A</a>	Ack Button
<a href="#">PDA2361-B</a>	Blank Button
<a href="#">PDA2361-R</a>	Reset Button
<a href="#">PDA2361-T</a>	Tare Button
<a href="#">PDA2361-S</a>	Stop Button
<a href="#">PDA2361-Q</a>	Silence Button

**Note:**

- Unless otherwise specified, the above accessories do not carry hazardous area approvals and are thus not suitable for location in hazardous areas.

Pipe Mounting Kits	
Model	Description
<a href="#">PDA6846</a>	2" Zinc Plated Steel U-Bolt Kit with One U-Bolt
<a href="#">PDA6846-SS</a>	2" Stainless Steel U-Bolt Kit with One U-Bolt



Watch the Loop-Powered Meters Video

*Click or scan*

**⚠ WARNING**

Cancer and Reproductive Harm - [www.P65Warnings.ca.gov](http://www.P65Warnings.ca.gov)

**Disclaimer**

The information contained in this document is subject to change without notice. Precision Digital Corporation makes no representations or warranties with respect to the contents hereof, and specifically disclaims any implied warranties of merchantability or fitness for a particular purpose.

©2023 Precision Digital Corporation. All rights reserved.

LDS6928\_B 02/23