

PD8-6001 Explosion-Proof Analog Input Feet & Inches Meter

Data Sheet



ProtEX™
MAX



MeterView Pro

USB Install

- Fully Approved Explosion-Proof Meter
- 0-20 mA, 4-20 mA, 0-5 V, 1-5 V, and ± 10 V Field Selectable Inputs with $\pm 0.03\%$ Accuracy
- Feet & Inches Display Ideal for Level Applications
- Dual-Line 6-Digit Display, 0.6" (15 mm) & 0.46" (12 mm)
- CapTouch Through-Glass Button Programming
- Display Mountable at 0°, 90°, 180°, & 270°
- Isolated 24 VDC @ 25 mA Transmitter Power Supply
- Easy Field Scaling in Engineering Units without Applying an Input
- 4 Relays with Interlocking Capability + Isolated 4-20 mA Output Option
- Free PC-Based, On-Board, MeterView Pro USB Programming Software
- SunBright Display Standard Feature; Great for Outdoor Applications
- Operating Temperature Range: -55 to 65°C (-67 to 149°F)
- CSA Certified as Explosion-Proof / Dust-Ignition-Proof / Flame-Proof
- ATEX and IECEx Certified as Dust-Ignition-Proof / Flame-Proof
- Input Power Options: 85-265 VAC / 90-265 VDC or 12-24 VDC / 12-24 VAC
- Display Input in Two Different Scales Simultaneously - Great for Level Applications
- Multi-Pump Alternation Control
- Round Horizontal Tank Function; Just Enter Diameter & Length
- 8-Point Linearization for Non-Linear Volume Measurements
- Password Protection
- Programmable Display, Function Keys & Digital Inputs
- Flanges for Wall or Pipe Mounting
- Explosion-Proof Aluminum or Stainless Steel NEMA 4X / IP68 Enclosures
- On-Board RS-485 Serial Communications
- Modbus® RTU Communication Protocol Standard
- Four 3/4" NPT Threaded Conduit Openings
- Stainless Steel Pipe Mounting Kit
- Stainless Steel Tag Available
- 3-Year Warranty

FLUIDPRO

Dosing Systems

www.fluidprodosing.com.au

QLD 07 3071 7415 NSW 02 8069 2664 VIC 03 9021 6624

PRECISION DIGITAL CORPORATION

**PRECISION
DIGITAL**

www.predig.com

The Complete **ProtEX™** Series MAX



 IECEx 



PD8-154
**4-Point Alarm
Annunciator**



PD8-6100
Strain Gauge Meter



PD8-158
**8-Point Alarm
Annunciator**



PD8-6200
**Analog Input
Flow Rate/Totalizer**



PD8-765
**Process &
Temperature Meter**



PD8-6210
**Analog Input Batch
Controller**



PD8-6000
Process Meter



PD8-6262
**Analog Dual-Input
Flow Rate/Totalizer**



PD8-6001
**Feet & Inches
Level Meter**



PD8-6300
**Pulse Input
Flow Rate/Totalizer**



PD8-6060
**Dual-Input
Process Meter**



PD8-6310
**Pulse Input
Batch Controller**



PD8-6080
**Modbus® Scanner
with Dual Analog Input**



PD8-6363
**Pulse Dual-Input
Flow Rate/Totalizer**



PD8-6081
**Feet & Inches
Modbus® Scanner**



PD8-7000
Temperature Meter

Go to PREDIG.COM for details on the entire ProtEX-MAX Series Meters



TABLE OF CONTENTS

OVERVIEW	4
TRANSMITTER POWER SUPPLIES	5
ADVANCED DISPLAY FEATURES	6
CAPTOUCH THROUGH-GLASS BUTTONS	7
QUICK & EASY SCALE & PROGRAMMING METHODS	8
4-20 mA OUTPUT & RELAYS	11
INPUT SIGNAL CONDITIONING	14
DIGITAL COMMUNICATIONS	15
PHYSICAL FEATURES	16
VIDEOS TO WATCH	18
OPERATIONAL FEATURES.	18
ACCESSORIES.	21
DIMENSIONS	23
CONNECTIONS	23
SPECIFICATIONS	24
ORDERING INFORMATION.	28

OVERVIEW



Connections

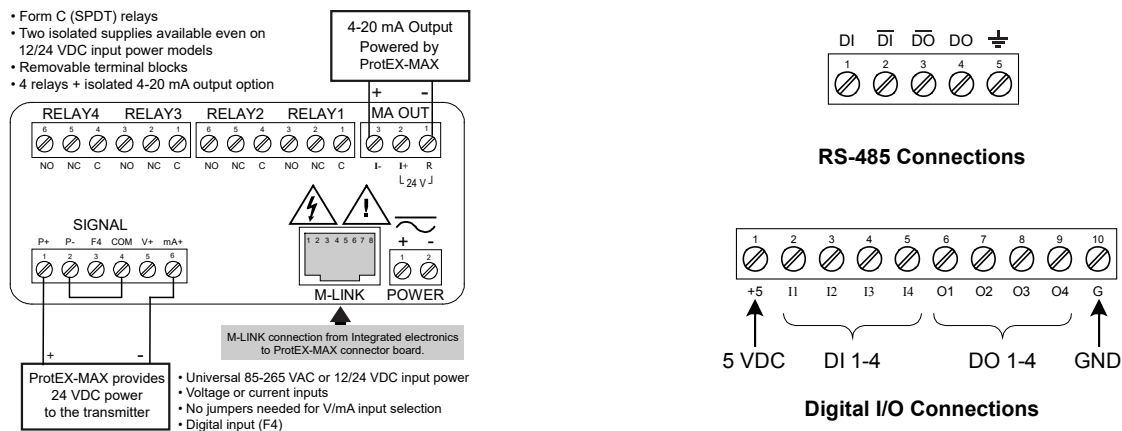

Connections for PD8-6001-6H7 & PD8-6001-7H7

The Only Explosion-Proof Feet & Inches Process Meter You Will Ever Need

Front, back and in between, the PD8-6001 ProtEX-MAX explosion-proof process meter boasts specifications, features and functionality that make it the only hazardous area process meter you will ever need. The front panel push-buttons can even be operated in a hazardous area without removing the cover by using the CapTouch through-glass feature.

The primary function of this meter is to display level from a 4-20 mA output transmitter in feet and inches format rather than the more common decimal format. The PD8-6001 has all the same features as our PD6001 1/8 DIN process meter and is certified by CSA as Explosion-Proof / Dust-Ignition-Proof / Flame-Proof, and is and is ATEX and IECEx certified as Dust-Ignition-Proof / Flame-Proof. Besides being suitable for hazardous areas, the number one feature that makes the PD8-6001 such a useful device is its built-in 24 VDC power supply to drive the transmitter as illustrated by the above diagram. This feature not only saves the cost of an external power supply, but also greatly simplifies wiring. In addition,

there is a second 25 mA power supply provided with the 4-20 mA output option.

The first thing you notice about the PD8-6001 is its modern looking, rugged, explosion-proof housing with convenient mounting flanges, available in aluminum or stainless steel. Housed inside this enclosure is a dual-line, 6-digit display with high-intensity LEDs that can be read in direct sunlight. It is ideal for level applications requiring an easy-to-understand display, as it shows feet, inches, and fractions of an inch. Other key features include four relays and 4-20 mA output option, advanced signal input conditioning like automatic round horizontal tank linearization, function keys, pump alternation capability, and Modbus RTU serial communications. Finally, all these features and capabilities can easily be programmed without removing the cover using CapTouch through-glass buttons in a hazardous area or with free MeterView Pro PC-based software in a safe area.

TRANSMITTER POWER SUPPLIES

Meter Powers Transmitter

One of the most useful standard features of the PD8-6001 is its built-in isolated, 24 V @ 25 mA power supply to power the transmitter. This feature saves money by eliminating an external power supply and also simplifies wiring by reducing the number of devices in the loop. It can be configured for 5, 10, or 24 V (default) by means of a simple internal jumper. This power supply is even available on meters that are powered from DC power (24 V @ 25 mA). To use an external power supply instead of the internal power supply, simply make connections to different terminals on the ProtEX-MAX.

The following diagram illustrates how to wire the ProtEX-MAX so it will power the transmitter:

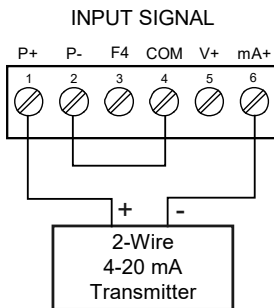

Meter Powers 4-20 mA Output

Not only can the ProtEX-MAX power the 4-20 mA input signal, but an additional power supply of 24 V @ 25 mA is provided with the 4-20 mA output option to power the 4-20 mA output.

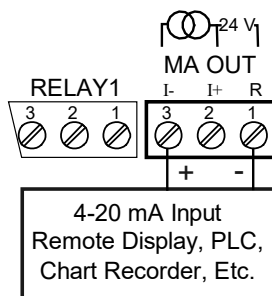

Fuse Prevents Current Overload

Another very useful aspect of the ProtEX-MAX is that the current input is protected against current overload by a resettable fuse. The fuse limits the current to a safe level when it detects a fault condition, and automatically resets itself when the fault condition is removed.



ADVANCED DISPLAY FEATURES

Display Level the Way You Want

The PD8-6001 is the perfect meter for customers who prefer to see level measurements displayed in feet and inches (12^{FT}11^{IN} 7/16) vs the more standard decimal format (12.953 feet). And for customers that want to see the level in feet and inches and also the actual volume in the tank, the PD8-6001's second display can be scaled to display the input in gallons, liters, barrels, etc.



Feet & Inches Display



Common Decimal Display

Rounding Feature for Even Steadier Display

The rounding feature is used to give the user a steadier feet and inches display with fluctuating signals. Rounding is used in addition to the filter function. Rounding is only applicable if the second display is setup to display level unit tags (d L -u). Rounding will round the second display to the nearest decimal value according to the rounding selected. The main display's level reading will be adjusted to match the rounded decimal value. See examples below:

Rounding Selection	Actual Value	Second Display Value	Main Display
1	12.093	12.093	12 ^{FT} 11 ^{IN} 2/16
	12.953	12.953	12 ^{FT} 11 ^{IN} 7/16
5	12.093	12.095	12 ^{FT} 11 ^{IN} 2/16
	12.953	12.955	12 ^{FT} 11 ^{IN} 7/16
10	12.093	12.090	12 ^{FT} 11 ^{IN} 1/16
	12.953	12.950	12 ^{FT} 11 ^{IN} 6/16
50	12.093	12.100	12 ^{FT} 11 ^{IN} 3/16
	12.953	12.950	12 ^{FT} 11 ^{IN} 6/16

Dual-Line Makes All the Difference

The main display can be programmed to indicate PV, maximum (peak), minimum (valley), alternating maximum/minimum, one of four alarm set points, or Modbus input. The second display can be configured to display engineering units, set points, user defined messages, or simply turned off.

The ProtEX-MAX's dual-line display makes all the difference both when programming the instrument and when using it in the field. When programming the instrument, the dual-line display prompts for the needed information and also helps you keep track of where you are in the setup process. When using the instrument, the dual-line display provides more information such as displaying the input in two different scales like height and volume for a level application. We call this the Dual-Scale feature.

Programming Assistance

The ProtEX-MAX's dual-line display makes programming the instrument much easier because the second line prompts for the needed information and also helps you keep track of where you are in the setup process.



The ProtEX-MAX is prompting for the value for Input 2 and displaying the default value of 20.00 mA. The "2" in 20.00 is brighter than the rest of the digits indicating that it is the number that will be changed by the Up and Right arrows.



The ProtEX-MAX is now prompting for what the user wants Display 2 to be; that is the value that corresponds to 20 mA. In this case Display 2 is currently set to 20^{FT} 0^{IN} 0/16.

Dual-Scale Display Feature

The ProtEX-MAX PD8-6001 has a rather unique, and very flexible dual-scale capability. This is of particular value in level applications where a second scaled display can represent the measured input in a different form (i.e. gallons & height). Both displays are independently scaled and are based on the 4-20 mA input signal.



Height & Gallons



Height & Meters



Height & Percent



Height & Barrels

MeterView Pro can be used to program the ProtEX-MAX to display the input in two different scales:

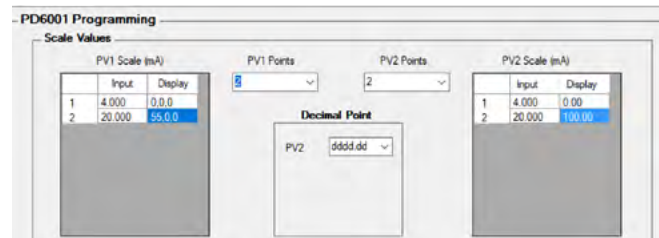

Super-Bright Display

The ProtEX-MAX comes standard with a super-bright display, with LEDs that are visible even in direct sunlight. The display also has up to eight levels of adjustable intensity for optimum visibility in any lighting condition.

CAPTOUCH THROUGH-GLASS BUTTONS

The ProtEX-MAX is equipped with four capacitive sensors that operate as through-glass buttons so that they can be operated without removing the cover (and exposing the electronics) in a hazardous area or harsh environment. CapTouch buttons are designed to protect against false triggering and can be disabled for security by selecting DISABLE on the switch labeled NO-CONTACT BUTTONS located on the connector board.

CapTouch Buttons

To actuate a button, press one finger to the window directly over the marked button area. When the cover is removed or replaced, the CapTouch buttons can be used after the meter completes a self-calibrating routine. The sensors are disabled when more than one button is pressed, and they will automatically re-enable after a few seconds. When the cover is removed, the four mechanical buttons located on the right of the faceplate are used.

The CapTouch Buttons are configured by default to duplicate the function of the front panel mechanical pushbuttons associated with the integrated meter.



Capacitive touch technology



More reliable & responsive



Operate meter without removing the cover

QUICK & EASY SCALE & PROGRAMMING METHODS

The ProtEX-MAX can be programmed either via the front panel push buttons or free, PC-based MeterView Pro software. MeterView Pro is resident on the ProtEX-MAX and is accessed by a provided USB cable, so it is by far the easiest way to program the ProtEX-MAX. The ProtEX-MAX can be calibrated either by applying a known signal or scaled by entering a desired value with the front panel buttons or MeterView Pro software. Most customers will use the scaling method because it is simpler and does not require a calibrated signal source. Selecting the input to be current or voltage is done with the front panel buttons or MeterView Pro software. Once programming is completed it can be locked with a password.

Free PC-Based MeterView Pro USB Programming Software & Cable

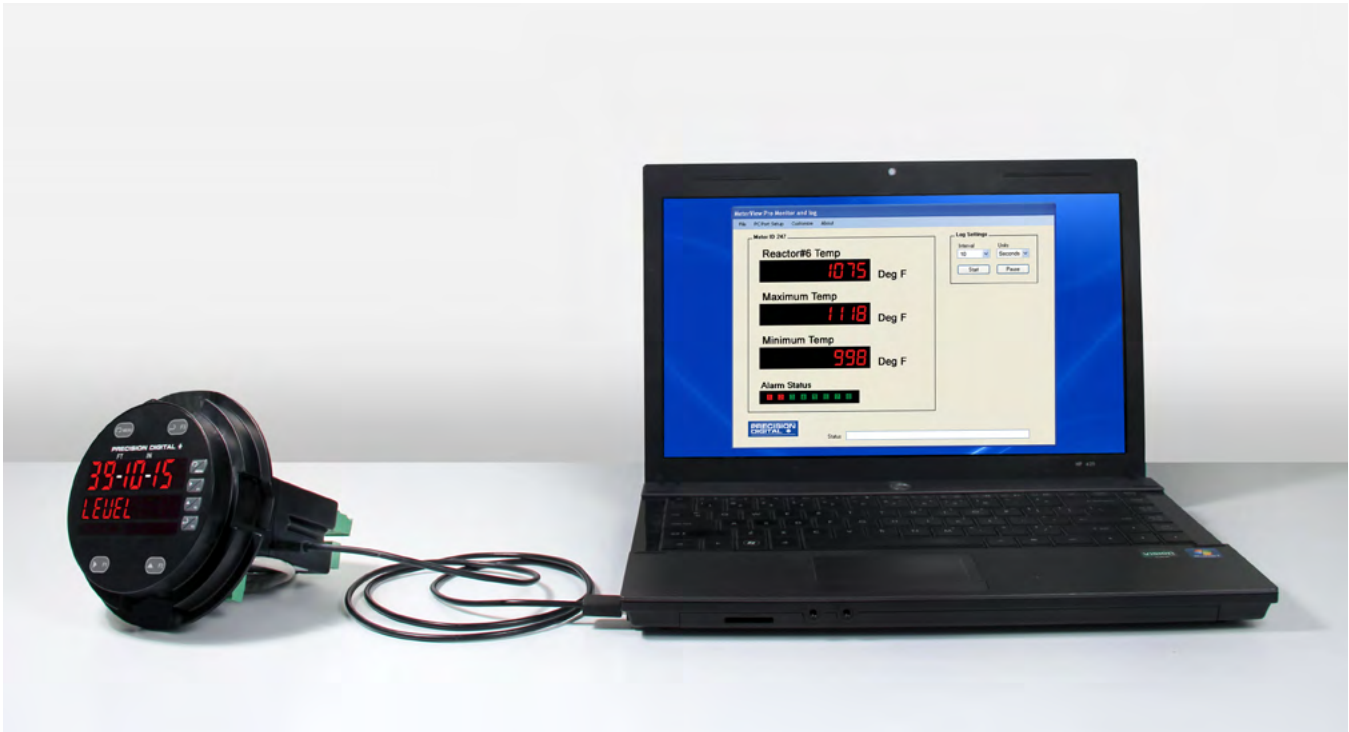

The ProtEX-MAX comes preloaded with free MeterView Pro programming software that connects and installs directly to your PC with a standard USB cable, also provided free with each instrument. This eliminates the need to insert CDs, install drivers, or download software from the internet. When you connect your ProtEX-MAX to your PC, MeterView Pro is downloaded to your PC, the software automatically selects the model you are programming, and you're ready to start programming immediately. Further simplifying the

programming process, the ProtEX-MAX can be powered from the USB port, so no need to apply external power while programming your meter. In addition to programming, the software will also allow you to monitor, and datalog a ProtEX-MAX using your PC. You can also generate and save programming files for later use.

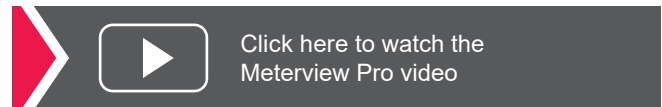

Setup Screen

- Select Current or Voltage Input
- Activate Dual-Scale (Level) Function
- Select Fractions of an Inch
- Set Line 1 Display Parameters
- Set Line 2 Display Parameters
- Set Analog Output Values
- Enable Manual Control
- Test Relays & Digital Outputs

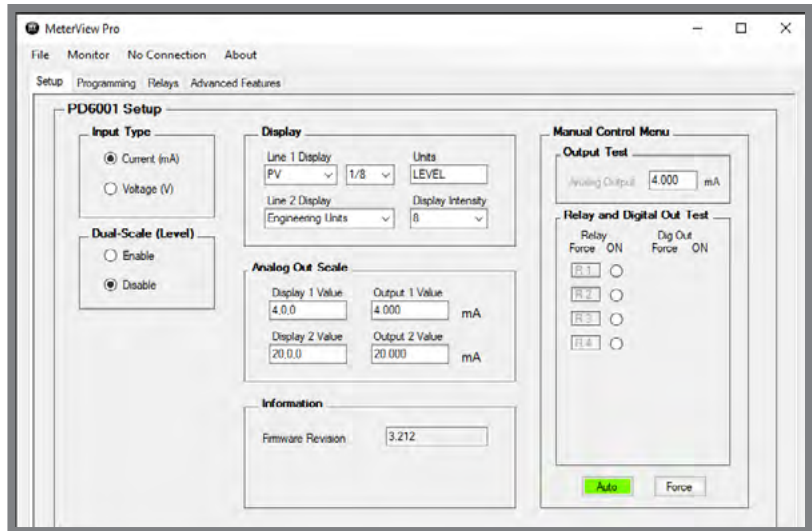

Programming Screen

- Set Scale Values
- Set the Number of Points (up to 32)
- Import from Excel
- Export to Excel

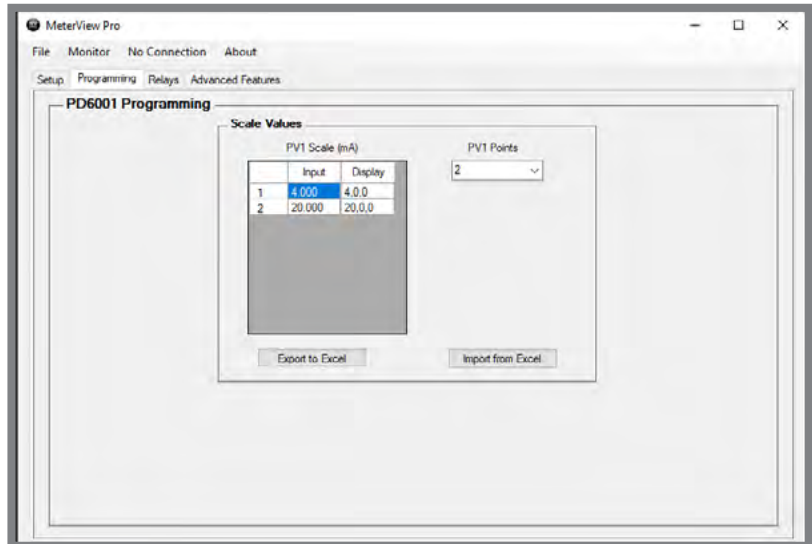

Relays Screen

- Greatly Simplifies Programming a Variety of Relay Features
- Set Relay Action
- Set Sampling Time
- Set Set & Reset Points
- Set On/Off Time Delays
- Set Fail Safe Operation
- Set Input Break Relay Action

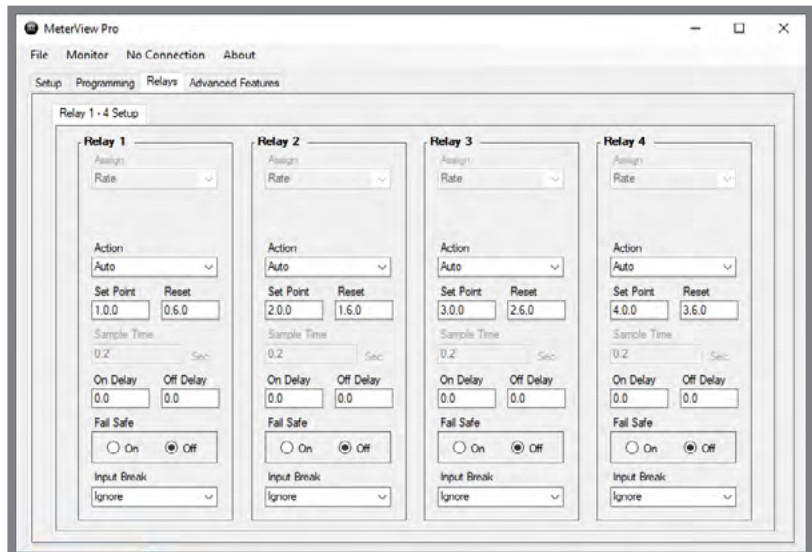

Save/Open Configuration

At the bottom of most MeterView screens are two tabs:

1. **Get Meter Data:** This reads the programming of the meter that is currently connected to the PC.
2. **Send Meter Data:** Clicking this button, sends current MeterView programming to the meter.

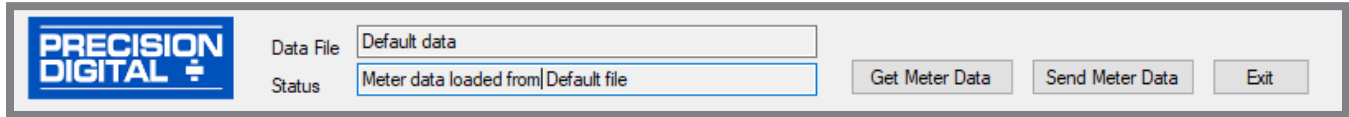

The configuration file can be sent or retrieved from the directory of your choice. This makes it very easy to program multiple meters with the same programming. It is also a great backup utility as well.

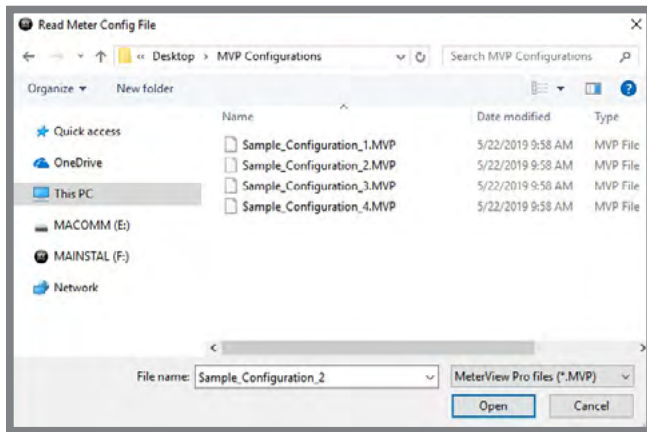

Specifications

System Requirements:

Microsoft® Windows® XP/Vista/7/8/10

Communications:

Onboard USB (firmware version 4.0 or higher),
RS-232 Adapter or RS-485 Adapter

Meter Address: 1 - 247

Reports:

- Data logging: Save as CSV file format
- Configuration: Save as PDC file format or print configuration

Baud Rate: 300 - 19,200 bps

Configuration: One meter at a time

Protocol:

Modbus RTU (requires firmware version 4.0 or higher)

**Note: Windows® 32/64-bit operating systems*

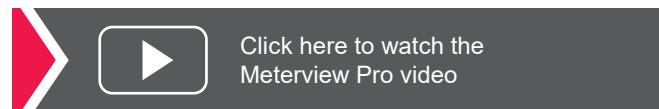

Password Protection

The Password menu is used for programming three levels of security to prevent unauthorized changes to the programmed parameter settings:

Pass 1: Allows use of function keys and digital inputs

Pass 2: Allows use of function keys, digital inputs and editing set/reset points

Pass 3: Restricts all programming, function keys, and digital inputs

4-20 mA OUTPUT & RELAYS

4-20 mA Analog Output

The isolated analog retransmission signal can be configured to represent the process variable (PV), maximum (peak) value, minimum (valley) value, the value for any of the four relay set points, or Modbus input. While the output is nominally 4-20 mA, the signal will accurately accommodate under- and over-ranges from 1 to 23 mA.

The 4-20 mA output can be reversed scaled such that 4 mA represents the high value and 20 mA represents the low value. For instance, a 4-20 mA output signal could be generated as the meter went from 50 FT⁰IN⁰ to 0 FT⁰IN⁰.

For applications where the input was linearized by the ProtEX-MAX, the 4-20 mA output will represent that linearized value.

Connections

The ProtEX-MAX can provide 25 mA at 24 VDC to power the 4-20 mA output signal or an external power supply can be used:

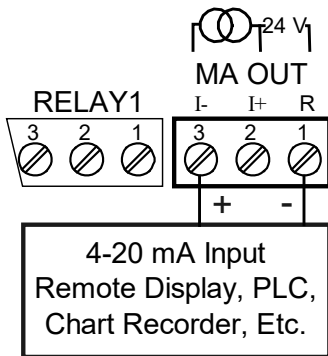

4-20 mA Output Powered by PD8-6001

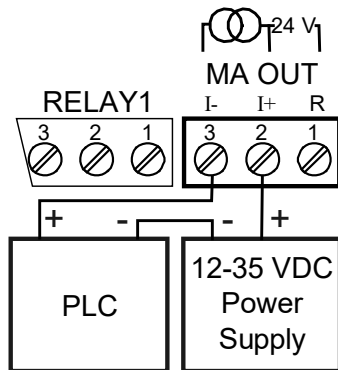

4-20 mA Output Powered by External Power Supply

The 4-20 mA output can either be programmed using the front panel push buttons or free MeterView Pro software.

Front Panel Push Button Programming

The 4-20 mA analog output can be scaled to provide a 4-20 mA signal for any display range selected. No equipment is needed to scale the analog output; simply program the display values to the corresponding mA output signal. The Analog Output menu is used to program the 4-20 mA output based on display values.

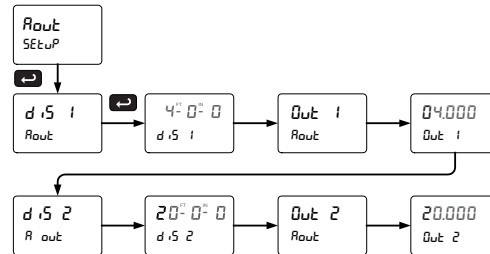

MeterView Pro Software Programming

When a meter is programmed as shown below, the output will be 4.00 mA when the display reads 4 FT⁰IN⁰ and the output will be 20.00 mA when the display reads 20 FT⁰IN⁰.

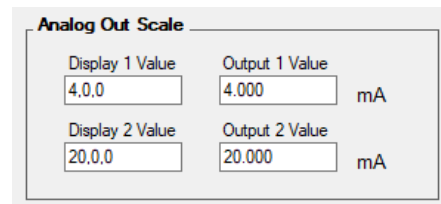

The meter can be set up for reverse scaling as shown below: the output will be 4.00 mA when the display reads 20 FT⁰IN⁰ and the output will be 20.00 mA when the display reads 4 FT⁰IN⁰.

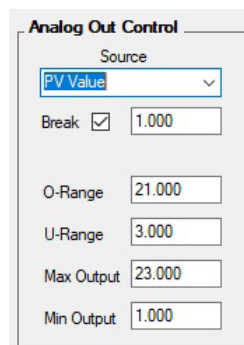
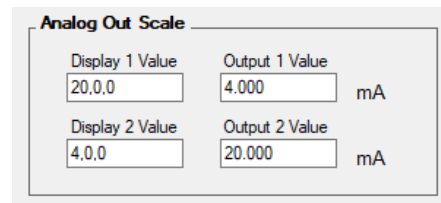

Source: Source for generating the 4-20 mA output (e.g. PV)

Overrange: Analog output value with display in overrange condition

Underrange: Analog output value with display in underrange condition

Break: Analog output value when loop break is detected

Max: Maximum analog output value allowed regardless of input

Min: Minimum analog output value allowed regardless of input

Relays for Hazardous Area Alarm & Control Applications

Adding relays to the ProtEX-MAX meter turns it into a sophisticated explosion-proof alarm device as well as a powerful, yet simple, alternative to a more complicated PLC system for control applications. One such application would be pump control using the ProtEX-MAX's relays in pump alternation mode. The ProtEX-MAX can be equipped with up to four 3 A Form C (SPDT) relays that can all be programmed to alternate, thus creating an explosion-proof pump alternator. Relays are highly user-configurable as the following screen shot from MeterView Pro indicates:

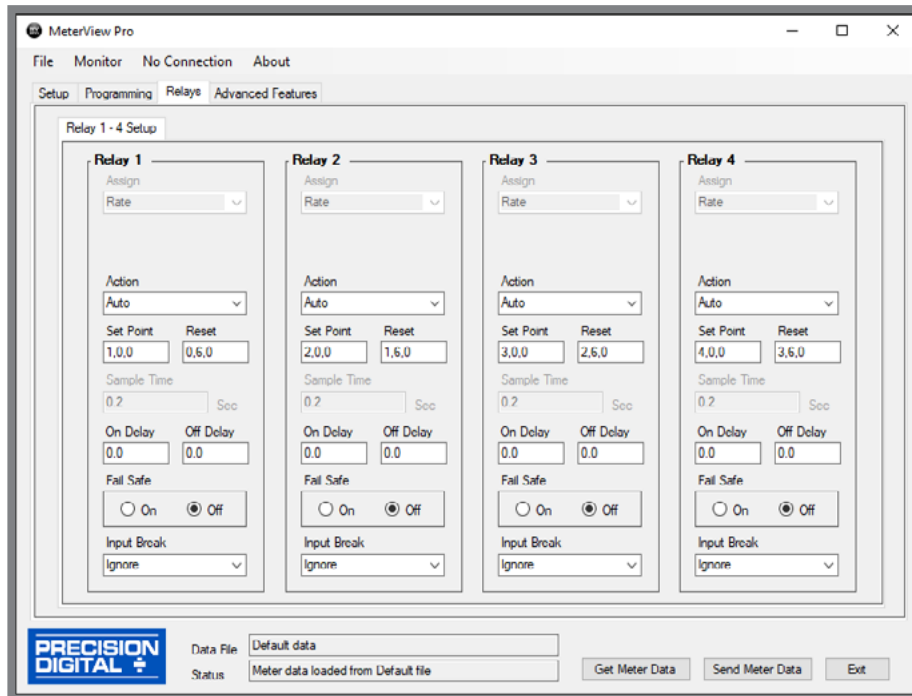

*Values are intended to show programming choices. They are not intended to represent an actual application.

Setting Set and Reset Points (HI / LO Alarms)

All relays are independent of each other and may be programmed as high or low alarms with user desired set and reset points. Setting a set point above a reset point results in a high alarm and setting a set point below a reset point results in a low alarm. Alarms have 0 – 100% deadband and set and reset points may be set anywhere in the range of the meter.

Resetting the Relays (Action in MV Pro)

All relays are independent of each other and may be programmed to reset (*Action* in MV Pro) in the following ways:

- **Automatic:** Alarm will reset automatically once the alarm condition has cleared.
- **Automatic/Manual:** Alarm will reset automatically once the alarm condition has cleared but can also be reset using the F3 front panel button* at any time.
- **Latching:** Alarm must be reset manually and can be done so at any time. Press the F3 front panel button* at any time to clear the alarm.
- **Latching with Reset after Cleared:** Alarm must be reset manually and can only be done so after the alarm condition has cleared. Press the F3 front panel button* after the alarm condition has cleared to reset the alarm.

* Or by connecting an external switch to F4 terminal or with an optional digital input.

Time Delay (On and Off)

In many applications it is desirable to wait before turning off or on a relay – such as waiting for a process to settle before taking action. Each relay on the ProtEX-MAX can be programmed with independent on and off time delays of 0 to 999.9 seconds to achieve this.

Relays Auto Initialization

When power is applied to the meter, the front panel LEDs and alarm relays will reflect the state of the input to the meter.

Signal Loss or Loop Break Relay Operation

When the meter detects a break in the 4-20 mA loop, the relay will go to one of the following selected actions:

1. Turn On (Go to alarm condition)
2. Turn Off (Go to non-alarm condition)
3. Ignore (Processed as a low signal condition)

User Selectable Fail-Safe Operation

All relays are independent of each other and may be programmed for user selectable fail-safe operation. With the fail-safe feature activated, the relays will transfer to the alarm state on power loss to the meter.

Front Panel LEDs

The meter is supplied with four alarm points that include front panel LEDs to indicate alarm conditions. This standard feature is particularly useful for alarm applications that require visual-only indication.

Manual Output Control

Take control of any output with this feature. All relays can be forced ON or OFF, and the 4-20 mA output signal can be set to any value



within its range. When the relays and 4-20 mA output are controlled manually, an LED labeled "M" is turned on and the associated Alarm LEDs (1-4) flash every 10 seconds indicating that the meter is in manual control mode.

Interlock Relay(s)

This function allows a process to use one or more very low voltage input signals or simple switch contacts to control the state of one or more internal "interlock" relays. A violation (i.e. loss of input, open switch, or open circuit) forces one or more N/O interlock relay contacts to open. One input can be used in series with a number of interlock switches, or up to eight inputs can be required to force-on one (or more) internal interlock relays. Please see *Safety Interlock on the ProVu Series* whitepaper on our website for more information.

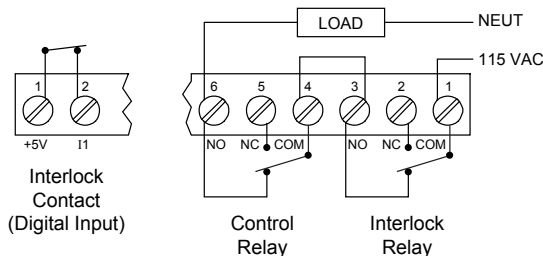

Switching Inductive Loads

The use of suppressors (snubbers) is strongly recommended when switching inductive loads to prevent disrupting the microprocessor's operation. The suppressors also prolong the life of the relay contacts. Precision Digital offers the PDX6901.

Explosion-Proof Multi-Pump Alternation

The ProtEX-MAX can be used as an explosion-proof pump controller when combined with a continuous level transmitter. The most common pump control application is shown below: controlling and alternating two pumps and providing high and low-level alarms. In addition, the ProtEX-MAX provides the 24 V to power the transmitter.

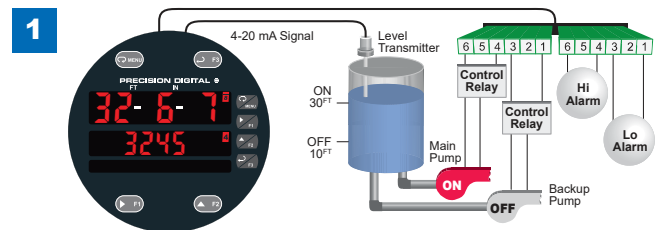

Relay #4 turns the main pump on at 30^{FT} and turns it off at 10^{FT}.

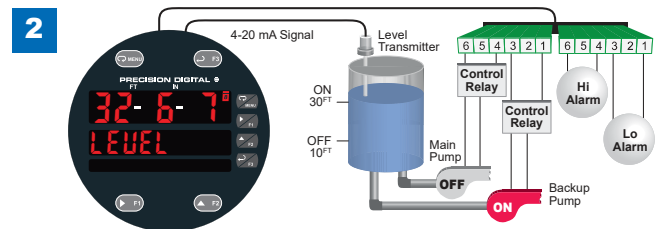

With the Pump Alternation feature activated, the next time the level reaches 30^{FT}, relay #3 transfers and starts the backup pump.

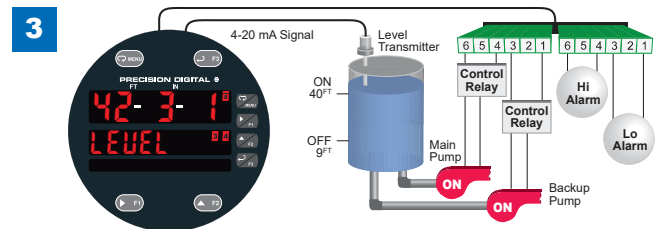

If the backup pump is not able to keep up, and the level reaches 40^{FT}, relay #4 transfers and starts the main pump as well.

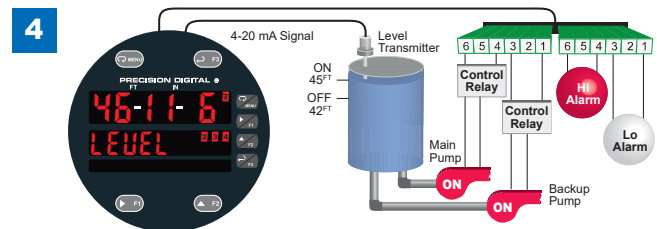

Relay #2 trips the High Level Alarm at 45^{FT} and resets at 42^{FT}.

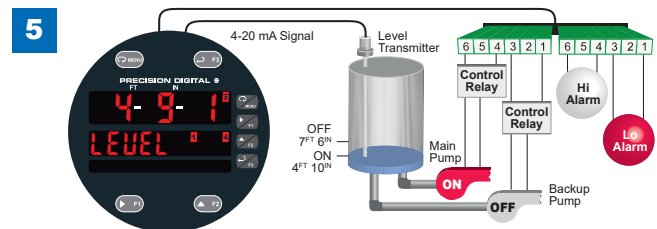

Relay #1 trips the Low Level Alarm at 4^{FT}10^{IN} and resets at 7^{FT}6^{IN}.

INPUT SIGNAL CONDITIONING

There are many applications in the industrial world that can't be satisfied with simple, two-point linear scaling so the ProtEX-MAX has advanced linearization capabilities to handle applications like round horizontal tank volume measurement. These features are most appropriate for the second display's decimal format.

Multi-Point Linearization

The most common way to linearize a non-linear signal is to break it up into smaller ranges that are more linear than the overall range. The ProtEX-MAX is available with up to 32 points of linearization and if dual scale feature is used, the second PV can have up to eight points of linearization. The linearization data can be imported from an Excel spreadsheet or can be exported from MeterView Pro to an Excel spreadsheet. The following screen shot from MeterView Pro shows PV1 with 2 points of linearization and PV 2 with 8 points of linearization:

The screenshot shows the MeterView Pro interface for configuring the PD6001. The 'Scale Values' section is active, showing two tables:

Point	Input	Display
1	4.000	4.0,0
2	20.000	20.0,0

Point	Input	Display
1	4.000	0.00
2	8.000	15.00
3	10.000	22.00
4	12.000	38.00
5	14.000	47.00
6	16.000	63.00
7	18.000	88.00
8	20.000	100.00

An Excel spreadsheet is overlaid on the right, showing the same data tables. Below the tables are 'Export to Excel' and 'Import from Excel' buttons.

Scale values can also be imported from an Excel spreadsheet.

Round Horizontal Tank Linearization

In addition to the generic 32- and 8-point linearization functions, the ProtEX-MAX is also available with specialized functions for round horizontal tanks. This function automatically calculates the volume in a round horizontal tank with flat ends and allows that reading to be displayed on the meter's second display. The user can now display level in feet and inches on the main display and volume on the second display. This feature is only available on PV2 since PV1 is the designated level indicator.

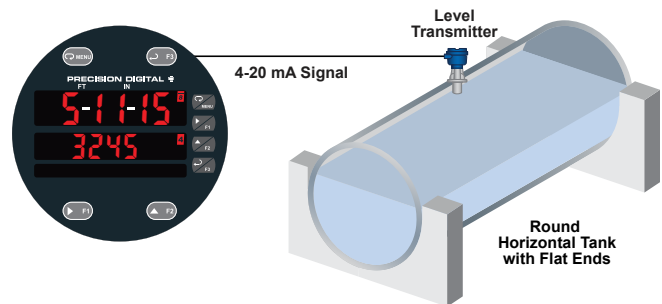

The screenshot shows the configuration screen for the RHT function. The 'Function' dropdown is set to 'RHT'. Below it, 'Diameter' is set to 72.000 and 'Length' is set to 120.000. There is an 'Inch' checkbox which is currently unchecked.

The user enters the diameter and length of a flat-ended round horizontal tank resulting in a display of volume.

In this application, a level sensor is measuring the height in the round horizontal tank and the ProtEX-MAX is converting that signal to volume using the RHT function. All the user has to do is input the diameter and length of the tank and the meter converts the signal to volume.

Linear 4-20 mA Analog Output

For applications where the input was linearized by the ProtEX-MAX, the 4-20 mA output will represent that linearized value.

DIGITAL COMMUNICATIONS

Modbus® RTU Serial Communications

With onboard RS-485 serial communication, the PD8-6001 can communicate with any Modbus *master* device using the popular Modbus communications protocol that is included in every ProtEX-MAX. In addition to the typical Modbus capabilities of reading PVs and writing set points, below are some examples of other things that can be done with the meter's Modbus communications:

- Send a 6-character message to the lower display upon an event
- Convert a digital value to a 4-20 mA signal
- Remote user control (i.e. change set points, acknowledge alarms)
- Input a Modbus digital PV (in place of analog input)
- Remote override of any or all relays and analog outputs



Modbus PV Input



Remote Message

 [Click here for more information on the ProVu's Modbus capabilities](#)

Serial Adapters & Converters*



PDA7485-I
RS-232 to RS-422/485
Isolated Converter



PDA8485-I
USB to
RS-422/485
Isolated Converter

 For more info on serial converters click here.

*All adapters and connectors supplied with appropriate cables.

Integrated Digital I/O and Serial Communications



Digital I/O Connections

Four digital inputs and four digital outputs come standard with the ProtEX-MAX. External digital inputs can function similarly to the front panel function keys or digital input F4. They can be configured to trigger certain events (i.e. acknowledge/reset alarms, reset max and/or min values, disable/enable all output relays, and hold current relay states), or provide a direct menu access point. The inputs can be connected to a multi-button control station to provide the user with remote control of the four front panel push buttons.

Digital outputs can be used to remotely monitor the ProtEX-MAX's alarm relay output states, or the states of a variety of actions and functions executed by the meter.

Note: The onboard digital inputs (1-4) are configured at the factory to function identically to the front panel pushbuttons (Menu, F1, F2, & F3) in order to work with the CapTouch buttons. Changing the programming of the digital inputs will affect the function of the CapTouch buttons.



Serial Communications Connections

ProtEX-MAX meters come with an RS-485 connection for serial communications with other digital devices. The industry standard Modbus RTU protocol is included with every meter.

PHYSICAL FEATURES

The ProtEX-MAX is designed for ease-of-use in safe and hazardous area applications, and is housed in a rugged NEMA 4X explosion-proof enclosure, available in either aluminum or stainless steel. The PD8-6001 can operate over a wide temperature range (-55 to 65°C / -67 to 149°F), includes removable screw terminal connectors, can have up to four relays and a 4-20 mA output, and features through-glass buttons for easy meter operation without the need to remove the cover. All of these features are backed by a 3-year warranty.

Super-Bright LED Display

The ProtEX-MAX features a dual-line 6-digit display with super-bright LEDs, our brightest ever. These allow the display to be read in any lighting condition, even in direct sunlight.



CapTouch Through-Glass Buttons

The ProtEX-MAX is equipped with four capacitive sensors that operate as through-glass buttons so that it can be programmed and operated without removing the cover (and exposing the electronics) in a hazardous area. These buttons can be disabled for security by selecting the DISABLE setting on the NO-CONTACT BUTTONS switch located on the back of the electronics module, inside the enclosure.

Rugged Explosion-Proof Enclosure

The ProtEX-MAX is housed in a rugged NEMA 4X, 7, & 9, IP68 aluminum or stainless steel enclosure, designed to withstand harsh environments in safe and hazardous areas.



Wide Viewing Angle

Customers can't always look at the display from straight on, so the window and display module have been optimized to provide a wide viewing angle of approximately $\pm 40^\circ$; nearly twice that of the competition.



Built-In Mounting Flanges

The ProtEX-MAX is equipped with two slotted flanges for wall mounting or NPS 1½" to 2½" or DN 40 to 65 mm pipe mounting.



Flexible Mounting & Wiring

The ProtEX-MAX features four ¾" NPT threaded conduit openings so that wiring can be routed to the most convenient conduit connection(s).



Rotatable Display

The ProtEX-MAX rotatable display, along with four available conduit connections, provide for numerous installation options. The display can be rotated in 90° increments. Rotate it 90° for horizontal mounting.



Vertical Mounting



Horizontal Mounting

Perfect & Secure Fit Every Time

The internal cast rails ensure the ProtEX-MAX assembles together perfectly, quickly and securely; and everything lines up for optimal viewing every time. There are no standoffs to worry about breaking or getting out of alignment. The display module snaps into the built-in rails on the enclosure making assembly a snap, while pressing the display as close to the glass as possible to improve wide angle viewing. No tools are needed to install or remove it.

PDA-SSTAG Stainless Steel Tags

PDA-SSTAG is a laser etched stainless steel tag accessory for any Precision Digital meter. The tag features custom text for equipment identification, instruction, or whatever else is needed in your facility. Each tag comes with a stainless steel wire and lead seal for easy mounting wherever you need it.



Removable Screw Terminal Connectors

Industrial applications require screw terminal connections for easy field wiring and the ProtEX-MAX goes one step further in convenience by also making them removable.

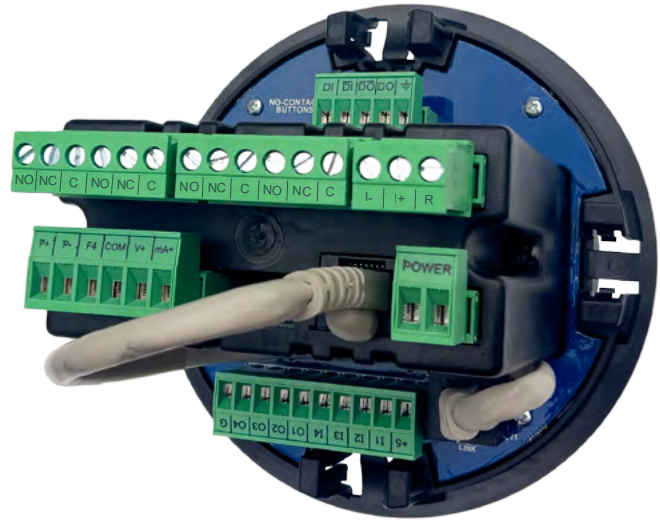

USB Port for MeterView Pro



Hazardous Area Certification

The ProtEX-MAX is certified by CSA as Explosion-Proof / Dust-Ignition-Proof / Flame-Proof and is approved by ATEX and IECEx as Dust-Ignition-Proof / Flame-Proof.

Wide Operating Temperature Range

The ProtEX-MAX can operate from -55 to 65°C (-67 to 149°F) meaning it can be installed in a wide variety of indoor and outdoor industrial applications.

VIDEOS TO WATCH



ProtEX-MAX Explosion-Proof Meters and Indicators

Learn About the ProtEX-MAX Series.

The ProtEX-MAX meter is very similar to the ProVu in features and functionality so the following videos might be of interest:



ProVu Series Overview

Learn About All the Meters in the ProVu Series!



ProVu Multi-Pump Alternation

Learn How to Use the ProVu as a Pump Controller.



ProVu Function Keys

Learn How the ProVu's Function Keys Increase the Utility of the ProVu.



Connect a ProVu to a PC Using MeterView Pro

Learn How Easy it is to Use MeterView Pro Software.

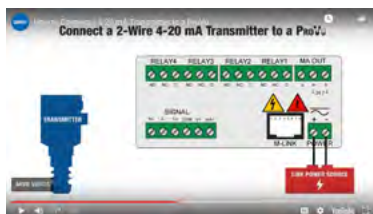

Connect a 2-Wire 4-20 mA Transmitter to a ProVu

Learn How to Connect Your Transmitter to a ProVu.

OPERATIONAL FEATURES

Function Keys, F4 Terminal, Digital Inputs

There are three ways the user can interact with the ProtEX-MAX to perform a variety of useful functions:

1. Three Front Panel Function Keys

The default settings for the function keys are:



Reset Max/Min Reading



Display Max/Min Reading



Acknowledge Relays

2. Built-in Digital Inputs/Outputs

The ProtEX-MAX comes with five digital inputs and four digital outputs. The digital inputs can be used to change the status of the relays, operate with the tare, reset tare, or interlock relays feature, and much more. The digital inputs can also be connected to an appropriately approved control station to provide remote control of the programming / operation buttons. The digital outputs can be used to send signals to PLCs and other devices.

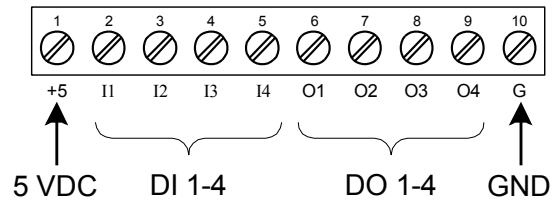

4 Digital Inputs & 4 Digital Outputs

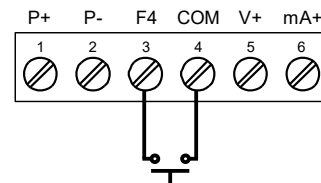

F4 Terminal for Digital Input

3. CapTouch Through-Glass Buttons

The ProtEX-MAX is equipped with four capacitive sensors that operate as through-glass buttons so that it can be programmed and operated without removing the cover (and exposing the electronics) in a hazardous area. The CapTouch buttons are configured by default to duplicate the function of the front panel mechanical pushbuttons associated with the integrated meter.

Function Key, Digital Inputs, & Digital Outputs Descriptions

The following table describes the actions that ProtEX-MAX function keys and digital inputs can be programmed to perform. The table also describes how the digital outputs can be programmed to remotely monitor the ProtEX-MAX’s alarm relay states, or the states of a variety of actions and functions executed by the meter.

Display	Description	Item
rSt H ₁	Reset the stored maximum display value	FK, DI, DO
rSt Lo	Reset the stored minimum display value	FK, DI, DO
rSt HL	Reset the stored maximum & minimum display values	FK, DI, DO
tArE	Capture tare and zero the display	FK, DI, DO
rSt tr	Reset captured tare and resume normal operation	FK, DI, DO
rELAY	Directly access the relay menu	FK, DI
SEt 1*	Directly access the set point menu for relay 1 (*through 8)	FK, DI
rLY d	Disable all relays until a button assigned to enable relays (rLY E) is pressed	FK, DI
rLY E	Enable all relays to function as they have been programmed	FK, DI
0 Hold	Hold current relay states and analog output as they are until a button assigned to enable relays (rLY E) is pressed	FK, DI
d Hold	Hold the current display value, relay states, and analog output momentarily while the function key or digital input is active. The process value will continue to be calculated in the background.	FK, DI
Ln1 H ₁	Display maximum display value on line 1	FK, DI
Ln1 Lo	Display minimum display value on line 1	FK, DI

Display	Description	Item
Ln1 HL	Display maximum & minimum display values on line 1	FK, DI
Ln2 H ₁	Display maximum display value on line 2	FK, DI
Ln2 Lo	Display minimum display value on line 2	FK, DI
Ln2 HL	Display maximum & minimum display values on line 2	FK, DI
F On 1*	Force relay 1 (*through 4) into the on state. This is used in conjunction with a digital input expansion module to achieve interlock functionality.	FK, DI
Control	Directly access the control menu	FK, DI
d ISAbL	Disable the selected function key or digital I/O	FK, DI
AcH	Acknowledge all active relays that are in a manual operation mode such as auto-manual or latching	FK, DI, DO
rESEt	Directly access the reset menu	FK, DI
mENu	Mimic the menu button functionality (digital inputs only)	DI
rIGHt	Mimic the right arrow/F1 button functionality (digital inputs only)	DI
uP	Mimic the up arrow/F2 button functionality (digital inputs only)	DI
EntEr	Mimic the enter/F3 button functionality (digital inputs only)	DI
ALAr 1*	Provide indication when alarm 1 (*through 4) has been triggered (digital outputs only)	DO

FK: Function Keys DI: Digital Inputs DO: Digital Outputs

Watch video about the programmable function keys, digital inputs, and all the capabilities these features offer on the PROVu Series, which work similarly on the ProtEX-MAX.

Remote Operation of Front Panel Buttons

The user can operate the front panel buttons from a remote location by using digital inputs programmed in the following manner:

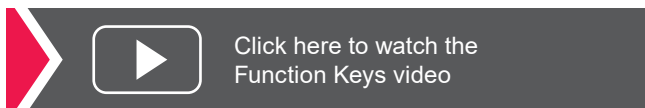
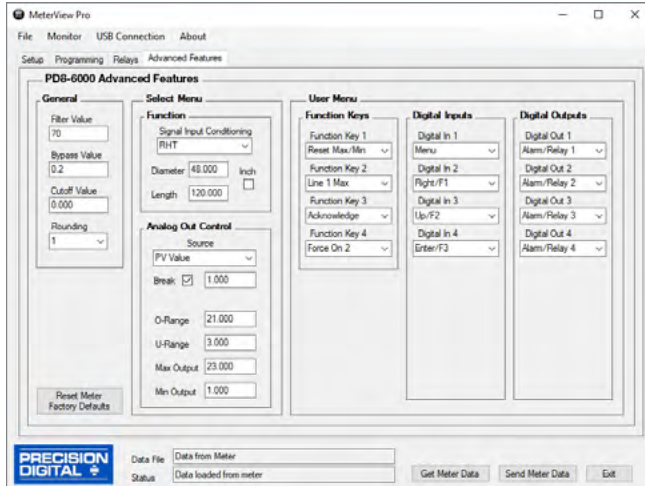

MeterView Pro Monitoring & Datalogging Software

Not only does free MeterView Pro software greatly simplify setup and programming of the ProtEX-MAX, it can also be used to monitor and datalog your process.

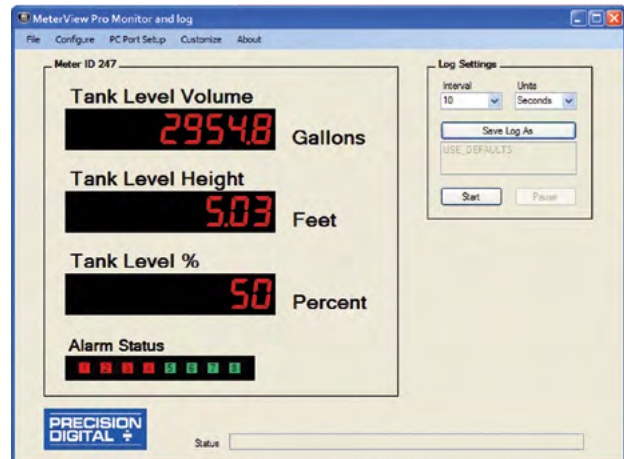

- Custom Tags: i.e. Tank Level Volume
- Custom Units: i.e. Gallons, Feet, Percent
- Alarm Status Indicators

Tare

The tare function zeros out the display. In the case of scale weight, tare is used to eliminate container weight and provide net weight readings. There are two tare functions; Capture Tare and Reset Tare. When the capture tare function is used, the display reading is offset by the displayed amount to make the displayed value zero. This modified display value is the net value. The originally displayed value without the tare offset is the gross value. Both may be chosen as a display option. Reset tare removes the display offset.



Reset tare removes the display offset of the net value, and the gross and net values become the same until a new capture tare is entered.

Max / Min Display

Max/Min (or Peak/Valley) is standard on the ProtEX-MAX PD8-6001. Either display can be configured to show either maximum or minimum excursion since last reset. The displays can also be configured to toggle between Max and Min values. Both values can be simply reset from the front panel.

Datalog Report

Collected data logger information can be sent to a CSV file for importing into a spreadsheet program. Below is an example of one such file. Of course, once within the spreadsheet, much can be done to customize the data.

Date & Time	PV1	Units	MAX	Units	MIN	Units	R1	R2	R3	R4	R5	R6
8/12/2022 10:39	0.06	Ft	0.06	Ft	0.06	Ft	Off	On	Off	Off		
8/12/2022 10:39	0.06	Ft	0.06	Ft	0.06	Ft	Off	On	Off	Off		
8/12/2022 10:39	0.06	Ft	0.06	Ft	0.06	Ft	Off	On	Off	Off		
8/12/2022 10:39	9.21	Ft	9.22	Ft	0.06	Ft	On	On	Off	Off		
8/12/2022 10:40	9.21	Ft	9.22	Ft	0.06	Ft	On	On	Off	Off		
8/12/2022 10:40	23.34	Ft	23.34	Ft	0.06	Ft	On	On	On	Off		
8/12/2022 10:40	38.56	Ft	32.90	Ft	0.06	Ft	On	On	On	On		
8/12/2022 10:40	38.81	Ft	38.82	Ft	0.06	Ft	On	On	On	On		
8/12/2022 10:40	32.94	Ft	38.82	Ft	0.06	Ft	On	On	On	On		
8/12/2022 10:40	32.94	Ft	38.82	Ft	0.06	Ft	On	On	On	On		
8/12/2022 10:41	19.106	Ft	38.82	Ft	0.06	Ft	On	On	On	Off		
8/12/2022 10:41	19.105	Ft	38.82	Ft	0.06	Ft	On	On	On	Off		
8/12/2022 10:41	13.50	Ft	38.82	Ft	0.06	Ft	On	On	On	Off		
8/12/2022 10:41	48.66	Ft	38.82	Ft	0.06	Ft	On	On	On	On		
8/12/2022 10:41	50.14	Ft	50.14	Ft	0.06	Ft	On	Off	On	On		
8/12/2022 10:41	37.33	Ft	50.14	Ft	0.06	Ft	On	Off	On	On		

Relay Control

Relays can be controlled from MeterView Pro for testing purposes. This is commonly done to determine whether the relays are functioning properly. In the *Setup* window, under *Relay and Digital Out Test* you have the option of selecting the relays you want in an ON state or OFF state and also whether you want to leave the relays in manual control or to return them to automatic operation.

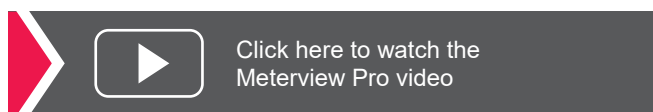

ACCESSORIES

PD9501 Multi-Function Calibrator



This PD9501 Multi-Function Calibrator has a variety of signal measurement and output functions, including voltage, current, thermocouple, and RTD.

Model	Description
PD9501	Multi-Function Calibrator

PD9502 Low-Cost Signal Generator



The PD9502 is a low-cost, compact, simple to use 4-20 mA or 0-10 VDC signal generator. It can easily be set for 0-20 mA, 4-20 mA, 0-10 V or 2-10 V ranges. Signal adjustment is made with a one-turn knob. A 15-27 VDC wall plug is provided with the instrument. Optional USB power bank is available.

Model	Description
PD9502	Low-Cost Signal Generator

⚠ WARNING

- These accessories do not carry hazardous area approvals and are thus not suitable for location in hazardous areas. The use of additional protective devices may allow them to be installed in a safe area and connected to a device in a hazardous area. User should consult a professional engineer to determine suitability of these products for their specific application.

Complete Product Line of Displays and Controllers IN ALL SHAPES, SIZES & LOCATIONS



Big, Bright Displays
For Indoor or Outdoor
in Bright Sunlight



Large Dual-Line
6-Digit Display



24 VDC
Transmitter
Power Supply



MeterView® Pro USB
Programming Software



Universal 85-265
VAC or 12-24 VDC
Input Power
Options



4-20 mA, 0-10 V,
Thermocouple, RTD,
Strain Gauge, High
Voltage, & Modbus Inputs



Up To Four
3 A Form C
Relays (SPDT)



SP Ex IECEx CE

EXPLOSION-PROOF ProtEX-MAX Series

- NEMA 4X, IP68 Rated Enclosure
- CapTouch Through-Glass Buttons
- Operating Temperature of -55 to 65°C
- Worldwide Approvals

LARGE DISPLAYS Helios Series

- 1.8" Digits Readable From 100 Feet
- NEMA 4X, IP65 Rated Enclosure
- Operating Temperature of -40 to 65°C
- Now UL and C-UL Approved!

UL CE

PANEL METERS ProVu Series

- NEMA 4X, IP65 Rated Front
- Programmable Function Keys
- UL, C-UL, and CE Approvals
- 1/8 DIN Size

Go to PREDIG.COM for details on ProVu, ProtEX-MAX and Helios Series Meters

DIMENSIONS

Units: Inches (mm)

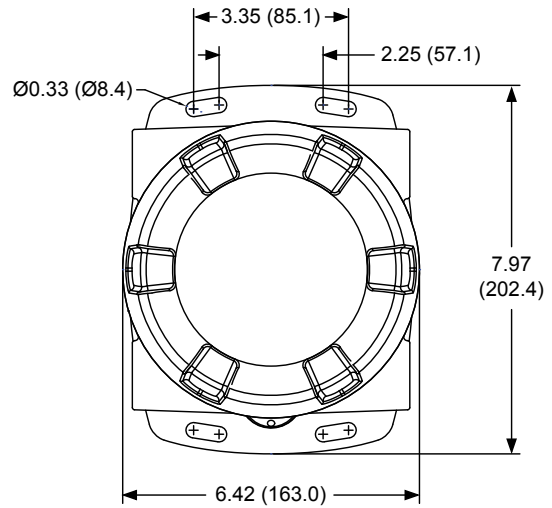
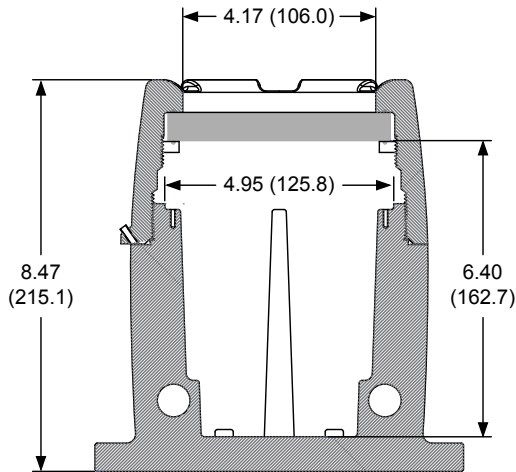

Download free 3-D CAD files of these instruments to simplify your drawings!

predig.com/documentation-cad

CONNECTIONS

- Form C (SPDT) relays
- Two isolated supplies available even on 12/24 VDC input power models
- Removable terminal blocks
- 4 relays + isolated 4-20 mA output option

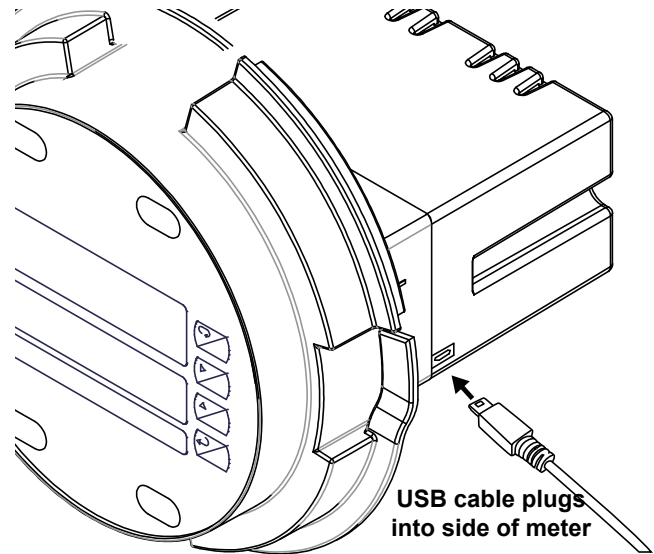
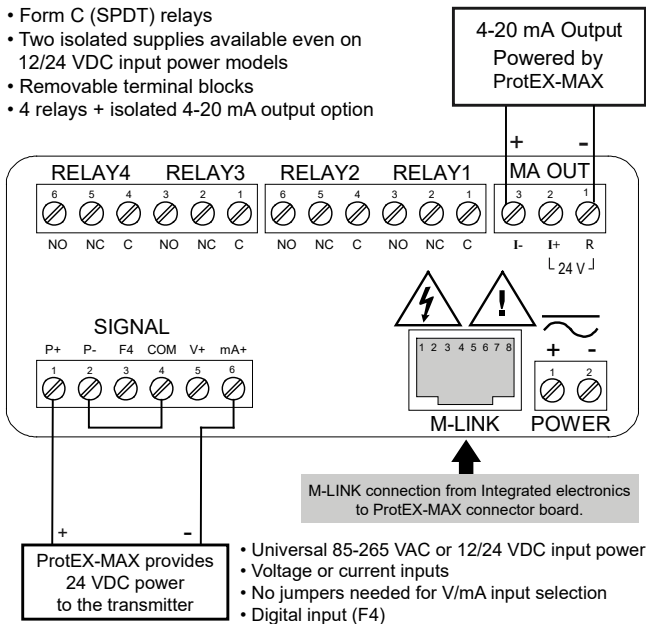

Connections for PD8-6001-6H7 & PD8-6001-7H7

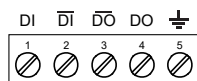

RS-485 Connections

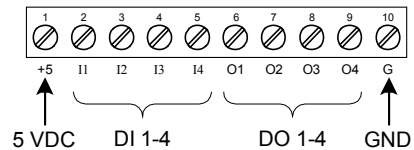

Digital I/O Connections

SPECIFICATIONS

Except where noted all specifications apply to operation at +25°C.

General

Display	Display Line 1: 0.60" (15 mm) high, red LEDs Display Line 2: 0.46" (12 mm) high, red LEDs 6 digits each (-99999 to 999999), with lead zero blanking
Feet & Inches Range	-9 ^{FT} 11 ^{IN} (¹⁵ / ₁₆ or ⁷ / ₈) to 99 ^{FT} 11 ^{IN} (¹⁵ / ₁₆ or ⁷ / ₈)
Display Intensity	Eight user selectable intensity levels. Default intensity is six.
Display Update Rate	5/second (200 ms)
Overrange	Display flashes 999999
Underrange	Display flashes -999999
Display Assignment	Display Line 1: PV1, max/min, max & min, set points, or Modbus® input Display Line 2: PV2, percent of PV1, set points, PV1 level in feet & unit/tag, max/min, max & min, Modbus®, engineering units, or turned off
Programming Methods	Four CapTouch through-glass buttons when cover is installed. Mechanical buttons can be used with the cover removed. Free PC-based USB MeterView Pro programming software.
Noise Filter	Programmable from 2 to 199 (0 will disable filter)
Filter Bypass	Programmable from 0.1 to 99.9% of calibrated span
Recalibration	All ranges are calibrated at the factory. Recalibration is recommended at least every 12 months.
Max/Min Display	Max/min readings reached by the process are stored until reset by the user or until power to the meter is turned off.
Rounding	Select 1, 2, 5, 10, 20, 50, or 100 (e.g. rounding = 10, actual value = 12.093, Line 2 display = 12.090, Line 1 display = 12 ^{FT} 1 ^{IN} ¹ / ₁₆)
Password	Three programmable passwords restrict modification of programmed settings. Pass 1: Allows use of function keys and digital inputs Pass 2: Allows use of function keys, digital inputs and editing set/reset points Pass 3: Restricts all programming, function keys, and digital inputs
Non-Volatile Memory	All programmed settings are stored in non-volatile memory for a minimum of ten years if power is lost.
Power Options	85-265 VAC 50/60 Hz; 90-265 VDC, 20 W max; 12-24 VDC, 12-24 VAC, 15 W max. Powered over USB for configuration only.
Fuse	Required external fuse: UL Recognized, 5 A max, slow blow; up to 6 meters may share one 5 A fuse
Normal Mode Rejection	Greater than 60 dB at 50/60 Hz
Isolation	4 kV input/output-to-power line 500 V input-to-output or output-to-P+ supply

Overvoltage Category	Installation Overvoltage Category II: Local level with smaller transient overvoltages than Installation Overvoltage Category III.
Environmental	T6 Class operating temperature range Ta = -55 to 60°C T5 Class operating temperature range Ta = -55 to 65°C Storage temperature range: -55 to 85°C (-67 to 185°F) Relative humidity: 0 to 90% non-condensing
Max Power Dissipation	Maximum power dissipation limited to 15.1 W
Connections	Power, signal, relays, mA out: Removable screw terminal blocks accept 12 to 22 AWG wire RS-485: Removable screw terminal block accepts 16 to 30 AWG wire Digital I/O: Removable screw terminal blocks accept 16 to 30 AWG wire
Mounting	Wall Mounting: Four (4) mounting holes provided for mounting meter to wall. Pipe Mounting: Optional pipe mounting kit (PDA6848) allows for pipe mounting. Sold separately.
Tightening Torque	Power, signal, relays, mA out terminals: 5 lb-in (0.56 Nm) Digital I/O and RS-485: 2.2 lb-in (0.25 Nm)
Overall Dimensions	6.42" x 7.97" x 8.47" (W x H x D) (163 mm x 202 mm x 215 mm)
Weight	Aluminum: 14.7 lbs (6.67 kg) Stainless Steel: 23.5 lbs (10.66 kg)
Warranty	3 years parts & labor. See Warranty Information and Terms & Conditions on www.predig.com for complete details.

Process Inputs

Inputs	Field selectable: 0-20 mA, 4-20 mA ±10 V (0-5 V, 1-5 V, 0-10 V) Modbus PV (Slave)									
Isolated Transmitter Power Supply	Terminals P+ & P-: 24 VDC ±10%. Isolated from the input at 500 V and from the power line at 4 kV. Jumper selectable for 24, 10, or 5 VDC supply (internal jumper J4). All models transmitter supply rated @ 25 mA max.									
Accuracy	±0.03% of calibrated span ±1 count									
Temperature Drift	0.005% of calibrated span/°C max from 0 to 65°C ambient, 0.01% of calibrated span/°C max from -40 to 0°C ambient									
Input Signal Conditioning	Linear or round horizontal tank volume calculation									
Multi-Point Linearization	2 to 32 points for PV or PV1 2 to 8 points for PV2 (Dual-scale Level feature)									
Round Horizontal Tank	Diameter & Length: 999.999 inch or cm calculates volume in gallons or liters respectively									
Low-Height Cutoff	0 ^{FT} 1 ^{IN} (⁰ / ₁₆ or ⁰ / ₈) to 99 ^{FT} 11 ^{IN} (¹⁵ / ₁₆ or ⁷ / ₈) (0 ^{FT} 0 ^{IN} (⁰ / ₁₆ or ⁰ / ₈) disables cutoff function)									
Decimal Point	Up to five decimal places or none: (PV2 only) d.ddddd, d.dddd, d.dddd, d.dd, d.d, or ddddd									
Calibration Range	<table border="1"> <tr> <td>Input Range</td> <td>Minimum Span</td> <td>Input 1 & 2</td> </tr> <tr> <td>4-20 mA</td> <td>0.15 mA</td> <td></td> </tr> <tr> <td>±10 V</td> <td>0.10 V</td> <td></td> </tr> </table> <p>An error message will appear if the input 1 and input 2 signals are too close together.</p>	Input Range	Minimum Span	Input 1 & 2	4-20 mA	0.15 mA		±10 V	0.10 V	
Input Range	Minimum Span	Input 1 & 2								
4-20 mA	0.15 mA									
±10 V	0.10 V									
Input Impedance	Voltage ranges: greater than 500 kΩ Current ranges: 50 - 100 Ω (depending on internal resettable fuse impedance)									
Input Overload	Current input protected by an internal resettable fuse, 30 VDC max. Fuse resets automatically after fault is removed.									
HART Transparency	The meter does not interfere with existing HART communications; it displays the 4-20 mA primary variable and it allows the HART communications to pass through without interruption. The meter is not affected if a HART communicator is connected to the loop. The meter does not display secondary HART variables.									

Relays

Relays	Field selectable: 0-20 mA, 4-20 mA ±10 V (0-5 V, 1-5 V, 0-10 V) Modbus® PV (Slave)
Rating	4 SPDT (Form C) internal and rated 3 A @ 30 VDC and 125/250 VAC resistive load; 1/14 HP (≈ 50 W) @ 125/250 VAC for inductive loads
Noise Suppression	Noise suppression is recommended for each relay contact switching inductive loads.
Deadband	0-100% of span, user programmable
High or Low Alarm	User may program any alarm for high or low trip point. Unused alarm LEDs and relays may be disabled (turn off).
Relay Operation	<ul style="list-style-type: none"> Automatic (non-latching) and/or manual reset Latching (requires manual acknowledge) with or without clear Pump alternation control (2-4 relays) Sampling (based on set point and time) Off (disable unused relays and enable Interlock feature) Manual on/off control mode
Relay Reset (Acknowledge)	User selectable via front panel button, F4 digital input, external contact closure on digital inputs, automatically via user selectable preset value and time delay, or through serial communications.
Time Delay	0 to 999.9 seconds, on & off relay time delays. Programmable and independent for each relay
Fail-Safe Operation	Programmable and independent for each relay Note: Relay coil is energized in non-alarm condition. In case of power failure, relay will go to alarm state.
Auto Initialization	When power is applied to the meter, relays will reflect the state of the input to the meter

USB Connection

Function	Programming only
Compatibility	USB 2.0 Standard, Compliant
Connector Type	Micro-B receptacle
Cable	USB A Male to Micro-B Cable
Driver	Microsoft® Windows® XP/Vista/7/8/10
Power	USB port provides power to the meter. DO NOT apply AC or DC power to the meter while the USB port is in use.

Isolated 4-20 mA Transmitter Output

Output Source	Process variable (PV), max, min, set points 1-4, Modbus® input, or manual control mode
Scaling Range	1.000 to 23.000 mA for any display range
Calibration	Factory calibrated: 4.000 to 20.000 = 4-20 mA output
Analog Out Programming	23.000 mA maximum for all parameters: Overrange, underrange, max, min, and break
Accuracy	± 0.1% of span ± 0.004 mA
Temperature Drift	0.4 µA/°C max from 0 to 65°C ambient, 0.8 µA/°C max from -40 to 0°C ambient Note: Analog output drift is separate from input drift.
Isolated Transmitter Power Supply	Terminals I+ & R: 24 VDC ±10%. Used to power the 4-20 mA output. All models rated @ 25 mA max
External Loop Power Supply	35 VDC maximum

RS-485 Serial Communications

Compatibility	EIA-485
Connectors	Removable screw terminal connector
Max Distance	3,937' (1,200 m) max
Status Indication	Separate LEDs for Power (METER LINK), Transmit (TX), and Receive (RX)

Modbus® RTU Serial Communications

Slave Id	1 – 247 (Meter address)
Baud Rate	300 – 19,200 bps
Transmit Time Delay	Programmable between 0 and 199 ms
Data	8 bit (1 start bit, 1 or 2 stop bits)
Parity	Even, Odd, or None with 1 or 2 stop bits
Byte-To-Byte Timeout	0.01 – 2.54 second
Turn Around Delay	Less than 2 ms (fixed) Note: Refer to the ProtEX-MAX Modbus® Register Tables located at www.predig.com for details.

Digital Input (F4)

Function	Remote operation of front-panel buttons, acknowledge/reset relays, reset max/min values.
Contacts	3.3 VDC on contact. Connect normally open contacts across F4 to COM
Logic Levels	Logic High: 3 to 5 VDC Logic Low: 0 to 1.25 VDC

Digital Inputs & Outputs

Function	Terminals provided for remote operation of all four programming / operation buttons. Other uses include acknowledge/reset relays and reset max/min values.
Channels	4 digital inputs & 4 digital outputs
Digital Input Logic High	3 to 5 VDC
Digital Input Logic Low	0 to 1.25 VDC
Digital Output Logic High	3.1 to 3.3 VDC
Digital Output Logic Low	0 to 0.4 VDC
Source Current	10 mA maximum output current
Sink Current	1.5 mA minimum input current
+5 V Terminal	To be used as pull-up for digital inputs only. Connect normally open push buttons across +5 V & DI 1-4.

WARNING

- DO NOT** use +5 V terminal to power external devices.

MeterView Pro Software

Availability	Download directly from meter or from www.predig.com/download_software
System Requirements	Microsoft® Windows® XP/Vista/7/8/10 USB 2.0 (for programming only)
Communications	USB 2.0 (for programming only) (USB A Male to Micro-B Cable) RS-485 to USB converter (programming, monitoring, and data logging)
Configuration	Configure meters one at a time
Power	USB port provides power to the meter. DO NOT apply AC or DC power to the meter while the USB port is in use.

Enclosure

Material	AL Models: ASTM A413 LM6 die-cast aluminum, copper-free, enamel coated SS Models: ASTM A743 CF8M investment-cast 316 stainless steel
Gasket	Fluoroelastomer
Rating	NEMA 4X, IP68 Explosion-proof
Color	AL: Blue SS: Silver
Window	Borosilicate glass
Conduits	Four 3/4" NPT threaded conduit openings
Conduit Stopping Plugs	Sold separately
Flanges	Two built-in flanges for wall and pipe mounting
Tamper-Proof Seal	Cover may be secured with tamper-proof seal
Overall Dimensions	6.42" x 7.97" x 8.47" (W x H x D) (163 mm x 202 mm x 215 mm)
Weight	AL: 14.7 lbs (6.67 kg) SS: 23.5 lbs (10.66 kg)
ATEX	 II 2 G D Ex db IIC Gb Ex tb IIIC Db IP66/IP68 Tamb: -55°C to +85°C Certificate No.: Sira 19ATEX1252U
IECEX	Ex db IIC Gb Ex tb IIIC Db IP66/IP68 Tamb: -55°C to +85°C Certificate No.: IECEX SIR 19.0075U
CSA	Class I, Division 1, Groups A, B, C, D Class II, Division 1, Group E, F, G Class III Ex db IIC Gb Ex tb IIIC Db Class I, Zone 1, AEx db IIC Gb Zone 21, AEx tb IIIC Db IP66/IP68/TYPE 4X Tamb: -55°C to +85°C Certificate No.: CSA19.80011200U
UL	Class I, Division 1, Groups A, B, C, D Class II, Division 1, Groups E, F, G Class III Class I, Zone 1, AEx db IIC Gb Zone 21, AEx tb IIIC Db Ex db IIC Gb Ex tb IIIC Db IP66/IP68/TYPE 4X Tamb: -55°C to +85°C Certificate Number: E518920

Note: The above approvals are for the enclosure only. See next page for approvals on the entire instrument.

General Compliance Information

Electromagnetic Compatibility

Emissions	EN 55022 Class A ITE emissions requirements
Radiated Emissions	Class A
AC Mains Conducted Emissions	Class A
Immunity	EN 61326-1 Measurement, control, and laboratory equipment EN 61000-6-2 EMC heavy industrial generic immunity standard
RFI - Amplitude Modulated	80 -1000 MHz 10 V/m 80% AM (1 kHz) 1.4 - 2.0 GHz 3 V/m 80% AM (1 kHz) 2.0 - 2.7 GHz 1 V/m 80% AM (1 kHz)
Electrical Fast Transients	±2kV AC mains, ±1kV other
Electrostatic Discharge	±4kV contact, ±8kV air
RFI - Conducted	10V, 0.15-80 MHz, 1kHz 80% AM
AC Surge	±2kV Common, ±1kV Differential
Surge	1KV (CM)
Power-Frequency Magnetic Field	30 A/m 70%V for 0.5 period
Voltage Dips	40%V for 5 & 50 periods 70%V for 25 periods
Voltage Interruptions	<5%V for 250 periods

Note: Testing was conducted on meters with cable shields grounded at the point of entry representing installations designed to optimize EMC performance.

Product Ratings and Approvals

CSA	Class I, Division 1, Groups B, C, D Class II, Division 1, Groups E, F, G Class III, Division 1, T5 Class III, Division 1, T6 (Ta max = 60°C) Ex db IIC T5 Ex db IIC T6 (Ta max = 60°C) Ex tb IIIC T90°C Ta = -55°C to +65°C Enclosure: Type 4X & IP66 / IP68 CSA Certificate: CSA 12 2531731
ATEX	II 2 G D Ex db IIC T* Gb Ex tb IIIC T90°C Db IP68 Ta = -55°C to +*°C *T6 = -55°C to +60°C *T5 = -55°C to +65°C Certificate Number: Sira 12ATEX1182X
IECEX	Ex db IIC T* Gb Ex tb IIIC T90°C Db IP68 Ta = -55°C to +*°C *T6 = -55°C to +60°C *T5 = -55°C to +65°C Certificate Number: IECEX SIR 12.0073X

ATEX/IECEX Specific Conditions of Use:

- The equipment label and epoxy coating may generate an ignition-capable level of electrostatic charges under certain extreme conditions. The user should ensure that the equipment is not installed in a location where it may be subjected to external conditions (such as high-pressure steam) which might cause a build-up of electrostatic charges on non-conducting surfaces. Additionally, cleaning of the equipment should be done only with a damp cloth.
- Flameproof joints are not intended to be repaired.
- All entry closure devices shall be suitably certified as "Ex d", "Ex t" and "IP66/68" as applicable. Suitable thread sealing compound (non-setting, non-insulating, non-corrosive, not solvent based, suitable for the ambient rating) must be used at the NPT conduit entries to achieve the IPx8 rating while maintaining the Ex protection concept.

Year of Construction

This information is contained within the serial number with the first four digits representing the year and month in the YYMM format.

For European Community

The ProtEX-MAX must be installed in accordance with the ATEX directive 2014/34/EU, the product manual, and the product certificate Sira 12ATEX1182X.

ORDERING INFORMATION

ProtEX-MAX PD8-6001 • Aluminum Enclosure		
85-265 VAC Model	12-24 VDC Model	Options Installed
PD8-6001-6H0	PD8-6001-7H0	None
PD8-6001-6H7	PD8-6001-7H7	4 Relays & 4-20 mA Output

Note: 24 V Transmitter power supply standard on all models.

ProtEX-MAX PD8-6001 • Stainless Steel Enclosure		
85-265 VAC Model	12-24 VDC Model	Options Installed
PD8-6001-6H0-SS	PD8-6001-7H0-SS	None
PD8-6001-6H7-SS	PD8-6001-7H7-SS	4 Relays & 4-20 mA Output

Note: 24 V Transmitter power supply standard on all models.

Accessories	
Model	Description
PDAPLUG75	3/4" NPT 316 Stainless Steel Stopping Plug with Approvals
PDA-SSTAG	Stainless Steel Tag
PDA6848-SS	Pipe Mounting Kit Stainless Steel
PDA7485-I	RS-232 to RS-422/485 Isolated Converter
PDA8485-I	USB to RS-422/485 Isolated Converter

Your Local Distributor is:

WARNING

Cancer and Reproductive Harm - www.P65Warnings.ca.gov

Disclaimer

The information contained in this document is subject to change without notice. Precision Digital Corporation makes no representations or warranties with respect to the contents hereof, and specifically disclaims any implied warranties of merchantability or fitness for a particular purpose.

©2023 Precision Digital Corporation. All rights reserved.

LDS8-6001_H 12/23