

PD8-765 Explosion-Proof Process & Temperature Meter

Data Sheet



ProtEX™
MAX

CAP TOUCH™



- CSA, ATEX and IECEx Certified Explosion-Proof Meter
- 4-20 mA, ± 10 V, TC & RTD Field Selectable Inputs
- Full 4-Digit Display, 1.20" (30.5 mm)
- CapTouch Through-Glass Button Programming
- Display Mountable at 0°, 90°, 180°, & 270°
- Isolated 24 VDC @ 200 mA Transmitter Power Supply Option (AC powered meters only)
- 2 Relays + Isolated 4-20 mA Output Option
- Free PC-Based MeterView Programming & Monitoring Software
- Sunlight Readable Display
- Operating Temperature Range: -55 to 65°C (-67 to 149°F)
- CSA Certified as Explosion-Proof / Dust-Ignition-Proof / Flame-Proof
- ATEX and IECEx Certified as Dust-Ignition-Proof / Flame-Proof
- Input Power Options: 85-265 VAC / 90-265 VDC or 12-36 VDC / 12-24 VAC
- Duplex Pump Controller with Alternation Capability
- External Contacts for Remote Button Operation
- On-Board RS-485 Serial Communications
- Modbus® RTU Communication Protocol Standard
- Copy Meter Settings to Other PD8-765 Meters
- Password Protection
- Max/Min Display
- High & Low Alarms with Multiple Reset Actions
- Flanges for Wall or Pipe Mounting
- Explosion-Proof Aluminum or Stainless Steel NEMA 4X / IP68 Enclosures
- Four 3/4" NPT Threaded Conduit Openings
- Stainless Steel Pipe Mounting Kit
- Stainless Steel Tag Available
- 3-Year Warranty

FLUIDPRO
Dosing Systems

www.fluidprodosingsystems.com.au

QLD 07 3071 7415 NSW 02 8069 2664 VIC 03 9021 6624

PRECISION DIGITAL CORPORATION

**PRECISION
DIGITAL**

www.predig.com

The Complete **ProtEX™** Series MAX



 IECEx 



PD8-154
**4-Point Alarm
Annunciator**



PD8-6100
Strain Gauge Meter



PD8-158
**8-Point Alarm
Annunciator**



PD8-6200
**Analog Input
Flow Rate/Totalizer**



PD8-765
**Process &
Temperature Meter**



PD8-6210
**Analog Input Batch
Controller**



PD8-6000
Process Meter



PD8-6262
**Analog Dual-Input
Flow Rate/Totalizer**



PD8-6001
**Feet & Inches
Level Meter**



PD8-6300
**Pulse Input
Flow Rate/Totalizer**



PD8-6060
**Dual-Input
Process Meter**



PD8-6310
**Pulse Input
Batch Controller**



PD8-6080
**Modbus® Scanner
with Dual Analog Input**



PD8-6363
**Pulse Dual-Input
Flow Rate/Totalizer**



PD8-6081
**Feet & Inches
Modbus® Scanner**



PD8-7000
Temperature Meter

Go to PREDIG.COM for details on the entire ProtEX-MAX Series Meters

TABLE OF CONTENTS

OVERVIEW	4	SERIAL COMMUNICATIONS	15
PROCESS & TEMPERATURE INPUTS	5	PHYSICAL FEATURES	16
ISOLATED TRANSMITTER POWER SUPPLIES	6	VIDEOS TO WATCH	17
ADVANCED DISPLAY FEATURES	7	OPERATIONAL FEATURES	18
QUICK & EASY SCALE & PROGRAMMING METHODS	8	DIMENSIONS	18
CAPTOUCH THROUGH-GLASS BUTTONS	11	ACCESSORIES	19
4-20 MA OUTPUT & RELAYS	12	CONNECTIONS	21
		SPECIFICATIONS	22
		ORDERING INFORMATION	25



**ACTUAL SIZE!
DIGITS ARE
1.2" (30.5 mm)
HIGH**

OVERVIEW



Connections

PD8-765-6X5-10

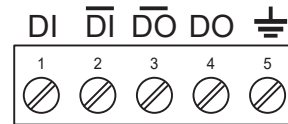
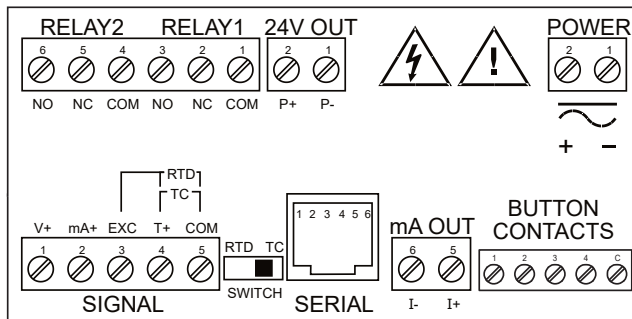

The ProtEX-MAX PD8-765 has a 5-position terminal block for connecting RS-485 serial devices.

Two SPDT relays; 24 V transmitter power; TC, RTD, 4-20mA or 0-10 VDC inputs; 4-20 mA output; four external button contacts

The Only Explosion-Proof Process & Temperature Meter You Will Ever Need

The ProtEX-MAX PD8-765 explosion-proof, large-display, process and temperature meter offers all the functionality of the PD765 Trident as a CSA, ATEX, and IECEx certified explosion-proof product. It can satisfy a wide variety of process applications. The PD8-765 can be field programmed to accept process voltage (0-5V, 1-5V, etc) and current (4-20 mA) inputs, 100 Ohm RTDs, and the four most common thermocouples.

There are two power options for the ProtEX-MAX: 85 to 265 VAC or 12-36 VDC and the AC powered version can provide 24 VDC to power the transmitter if needed. Programming and setup can be performed with the four CapTouch through-glass buttons, free MeterView software, or using the Copy function.

Two relays and isolated 4-20 mA output options increase the utility of the PD8-765. The relays can be used for alarm or control applications. The 4-20 mA output provides an isolated retransmission of the input signal; especially useful for temperature inputs like thermocouples and RTDs. Now you can have an explosion-proof temperature transmitter with a huge, bright display! It is housed in an explosion-proof housing with convenient mounting flanges, available in aluminum or stainless steel.

The PD8-765 ProtEX-MAX display height is an astounding 1.2" (30.5 mm). It can be read easily from distances of up to 30 feet away! The display intensity function allows the selection of eight levels of intensity for various lighting conditions, including direct sunlight.

PROCESS & TEMPERATURE INPUTS

The PD8-765 is factory calibrated to accept 4-20 mA, ± 10 VDC, type J, K, T, or E thermocouples and 100 Ω platinum RTDs. Process inputs can be scaled with or without applying an input for virtually any engineering units. Temperature inputs can be programmed to display in degrees Fahrenheit or Celsius and the type K thermocouple can display up to 2300°F.

Current & Voltage Inputs

Setting up the meter to accept a current or voltage input could not be easier. All setup is performed with the front panel buttons and there are no switches or jumpers to deal with.

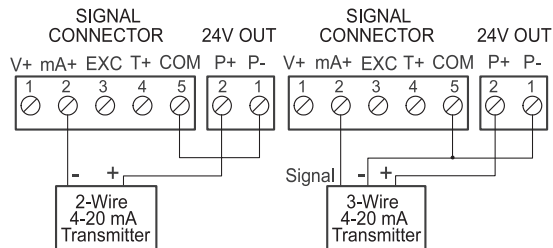

Transmitter Powered by Internal Supply (optional)

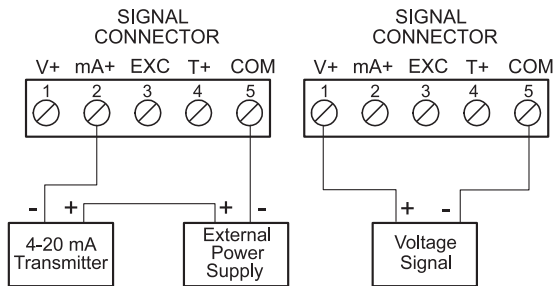

Transmitter Powered by External Supply

Current Overload Protection

To protect the instrument from unexpected current overload, the current input circuit contains a resettable fuse. The fuse limits the current to a safe level when it detects a fault condition, and automatically resets itself when the fault condition is removed.

Thermocouple & RTD Inputs

Setting up the PD8-765 to accept a thermocouple or RTD input is simply a matter of setting a switch at the rear of the case and selecting the input type from the menu. The meter accepts J, K, T, or E type thermocouples as well as two, three, or four-wire 100 Ω platinum RTDs.

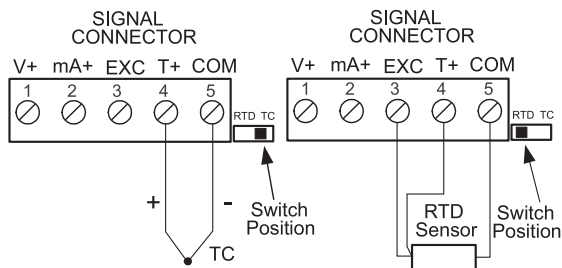

Temperature Inputs

The Trident meter accepts J,K,T or E thermocouples and 100 Ω platinum RTDs. For the T thermocouple and RTD, the user can display temperature to 1° or 0.1° resolution and the Type K thermocouple to 2300°F. In addition, these meters will operate down to -40°C with only minimal loss of accuracy.

Type	Range	Acc. (0-65°C)	Acc. (-40-0°C)	Resolution
J	-58° to 1382°F -50° to 750°C	$\pm 2^\circ\text{F}$ $\pm 1^\circ\text{C}$	$\pm 5^\circ\text{F}$ $\pm 3^\circ\text{C}$	1°
K	-58° to 2300°F -50° to 1260°C	$\pm 2^\circ\text{F}$ $\pm 1^\circ\text{C}$	$\pm 4^\circ\text{F}$ $\pm 2^\circ\text{C}$	1°
T	-292° to 700°F -180° to 371°C	$\pm 2^\circ\text{F}$ $\pm 1^\circ\text{C}$	$\pm 13^\circ\text{F}$ $\pm 7^\circ\text{C}$	1° or 0.1°
E	-58° to 1700°F -50° to 927°C	$\pm 2^\circ\text{F}$ $\pm 1^\circ\text{C}$	$\pm 11^\circ\text{F}$ $\pm 6^\circ\text{C}$	1°
RTD	-328° to 1382°F -200° to 750°C	$\pm 1^\circ\text{F}$ $\pm 1^\circ\text{C}$	$\pm 5^\circ\text{F}$ $\pm 3^\circ\text{C}$	1° or 0.1°

Explosion-Proof Temperature Transmitter with Huge Display

The PD8-765 ProtEX MAX, with the appropriate options, can be used as an explosion-proof, isolated temperature transmitter with a big display by converting the thermocouple or RTD input into an isolated 4-20 mA output.

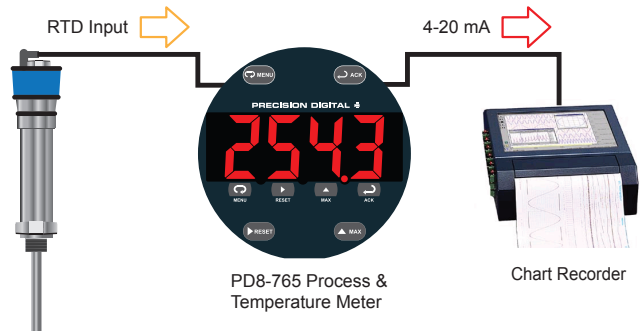

Display Flow Rate From a DP Transmitter

DP Flow via Square Root Extraction

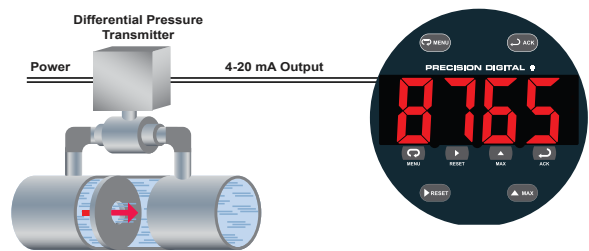

In this application, the PD8-765 is displaying flow rate by extracting the square root from the 4-20 mA signal from a differential pressure transmitter. The user selectable low-flow cutoff feature gives a reading of zero when the flow rate drops below a user selectable value.

TRANSMITTER POWER SUPPLIES

24 V @ 200 mA Transmitter Power Supply

One of the most useful features of the PD8-765 is its built-in, isolated, 24 V @ 200 mA power supply to power the transmitter. This feature saves money by eliminating an external power supply and also simplifies wiring. The following diagrams illustrate how to wire the PD8-765 so it will power the transmitter:

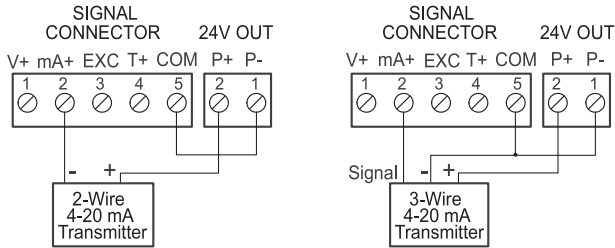

24 V @ 40 mA 4-20 mA Output Power Supply

Not only can the PD8-765 power the 4-20 mA input signal, but an additional power supply of 24 V @ 40 mA is available on select models to power the 4-20 mA output.

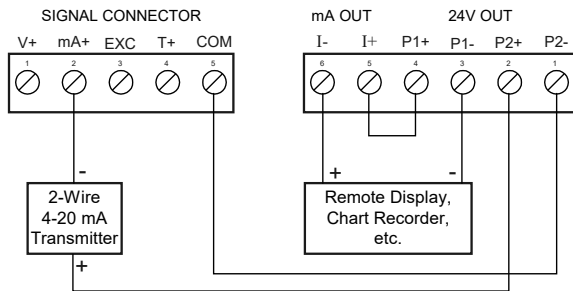

Connections for PD8-765-6X3-20 Only

Isolated 4-20 mA Transmitter Output

The PD8-765's isolated 4-20 mA output option converts the meter into a transmitter / loop isolator with a digital display; perfect for temperature applications!

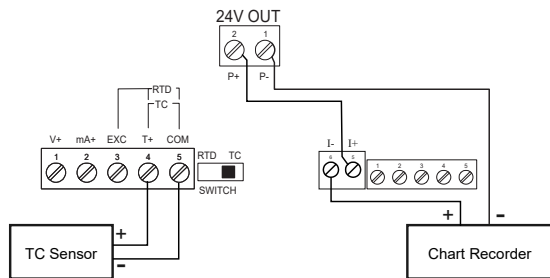

Resettable Fuse Prevents Current Overload

Another very useful aspect of the PD8-765 is that the current input is protected against current overload by a resettable fuse. The fuse limits the current to a safe level when it detects a fault condition, and automatically resets itself when the fault condition is removed.

Other Uses for Transmitter Power Supplies

The most common use for these two power supplies is for the 200 mA transmitter power supply to power the field transmitter and 40 mA power supply to power the 4-20 mA output from the meter. However, these two power supplies can be used in other ways. For instance, some level transmitters require the use of a heated lens. The PD8-765's 200 mA power supply could be used to power both the heated lens and the 4-20 mA signal from the transmitter.

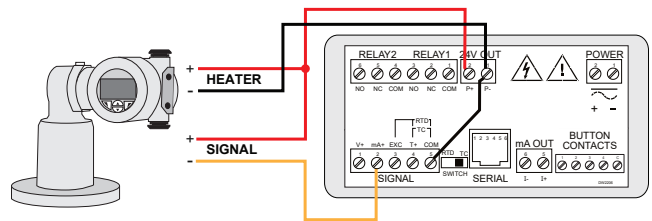

PD8-765 Powers Both the Heater and 4-20 mA Input Signal

External Power Supply for the Loop

For applications that require an external transmitter power supply, the same PD8-765 is used and merely wired in a different fashion as the following diagrams illustrate:

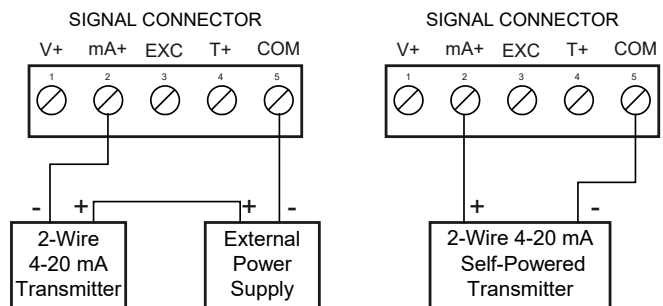

ADVANCED DISPLAY FEATURES

Four Full Digits

The display on the PD8-765 is four full digits which means it can display numbers up to 9999. Many digital devices have displays of only 3½ digits which means they can display only to 1999. In practical terms, this means the PD8-765 can display type K thermocouples to 2300°F and 4-20 mA signals up to 9,999.

Front Panel LEDs

The meter is supplied with two alarm points that include front panel LEDs to indicate alarm conditions. This standard feature is particularly useful for alarm applications that require visual-only indication.

Sunlight Readable Display

The intensity of the display on the ProtEX-MAX PD8-765 can be adjusted to compensate for various lighting conditions, including direct sunlight. In the advanced menu features menu, you can choose from eight levels of intensity depending on the visibility conditions.



The following diagram illustrates how to set the intensity on the PD8-765 process and temperature meter:

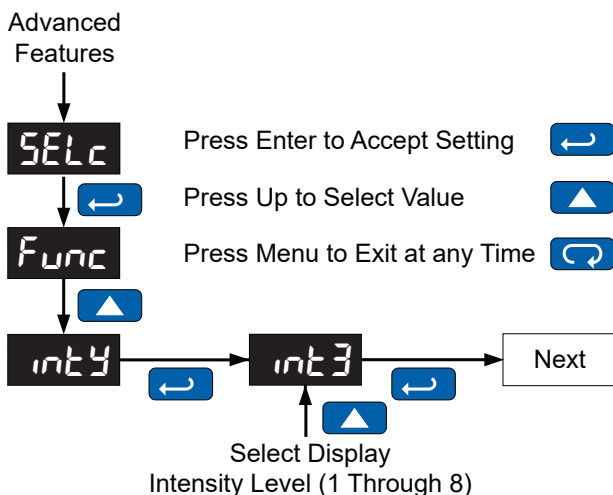

Large Display Size

The display height on the ProtEX-MAX PD8-765 is an astounding 1.2" (30.5 mm). It can be easily read from distances of up to 30 feet!

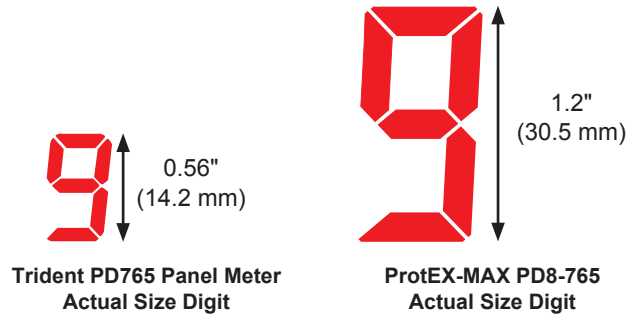

Display & Toggle Maximum / Minimum Reading

The main function of the front panel buttons during operation is to display the maximum and minimum readings reached by the process or temperature inputs. The PD8-765 allows you to toggle between the maximum and minimum readings of the process values. To display the maximum and minimum readings since the last reset/power-up, use the Up arrow/Max button.

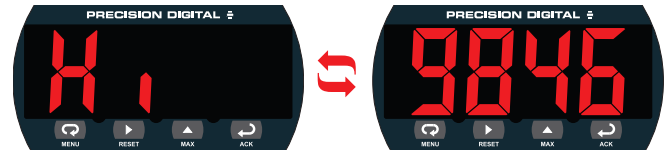

Display & Toggle Maximum Value

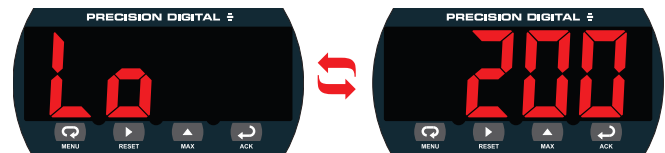

Display & Toggle Minimum Value

Wide Viewing Angle

Customers can't always look at the display from straight on, so the window and display module have been optimized to provide a wide viewing angle of approximately ±40°; nearly twice that of the competition.



QUICK & EASY SCALE & PROGRAMMING METHODS

The PD8-765 is easily setup and programmed without removing the cover by using the four through-glass CapTouch buttons or by removing the cover and using the front panel push buttons. The meter can also be programmed using a PC and Precision Digital's free MeterView software or "cloned" with the Copy function. Programming the PD8-765 with MeterView software requires removing the front cover and connecting to the electronics module to the PC via PDA8006 Trident USB serial adapter.

Free PC-Based MeterView Software

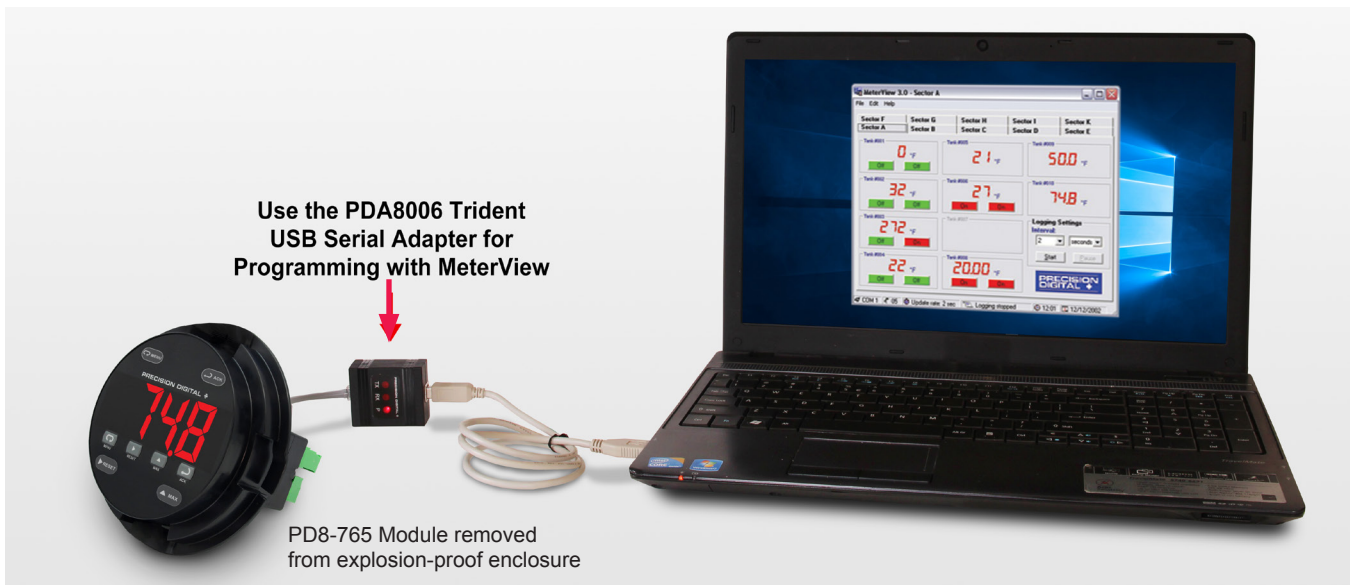

Note: PD8-765 meter is not powered from USB connection and requires external power to be programmed.

MeterView software allows all PD8-765 setup parameters to be programmed from a PC and to save the configuration settings to a file for reporting or programming other meters. For programming purposes, MeterView software connects to the PD8-765 meter via the low-cost PDA8006 USB serial adapter pictured above.

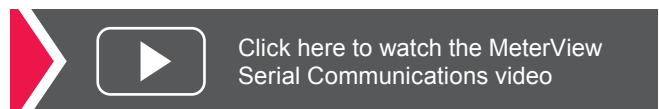

Meter Copy

The Copy function is used to copy (or clone) all the settings from one PD8-765 meter to other PD8-765 meters in less than 10 seconds. The Copy feature does not require a serial communication adapter, it only requires the optional cable assembly (PDA7420).



Note: The PD8-765 modules must be removed from the enclosures to connect the copy cable.

Programming with Four CapTouch Through-Glass Buttons

The PD8-765's four CapTouch through-glass buttons keep the user in control of the programming process. There is no need to remove the cover for programming. Just touch the glass over the CapTouch buttons for navigating through the menus. Try out the Trident Virtual Meter at predig.com/tvm and see how simple it is to program the PD8-765. It programs the same exact way as the Trident panel meter version.

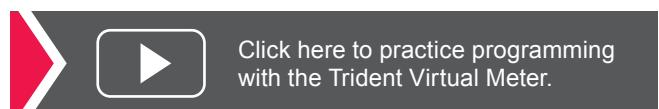
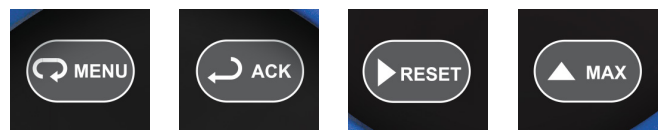

Programming From a PC with MeterView

Precision Digital's free MeterView software allows the PD8-765 setup parameters to be programmed from a PC and to save the configuration settings to a file for reporting or programming other meters. For programming purposes, MeterView software connects to the PD8-765 meter via the low-cost PDA8006 USB serial adapter. Below are examples of the various windows used to configure, scale, set relays / alarms, and program other advanced features.

Configure Input

- Input type
- Temperature units
- Sensor type

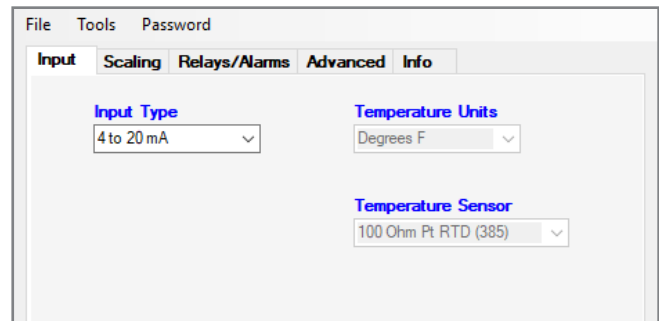

Meter Scaling

- Scale input
- Decimal point
- No cryptic codes
- Simple to use

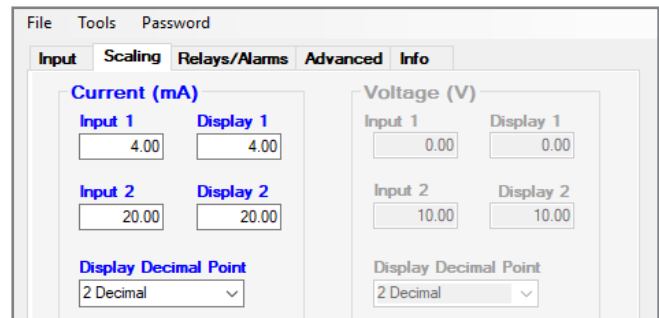

Set Relays/Alarms

- Select reset mode
- Set/reset points
- Fail-safe operation
- On & off delays

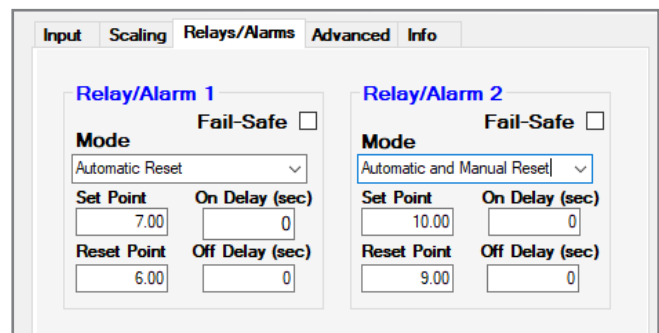

Advanced Settings

- Password
- Filter & bypass
- Transmit delay
- Display intensity level
- Function type
- Analog output scaling
- Sensor break

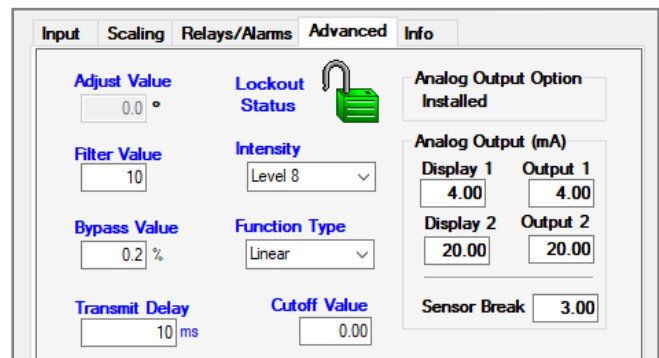

Save/Retrieve Configuration

MeterView software allows all PD8-765 setup parameters to be programmed from a PC and to save the configuration settings to a file for reporting or programming other meters. For programming purposes, MeterView software connects to the PD8-765 meter via the low-cost PDA8006 USB serial adapter.

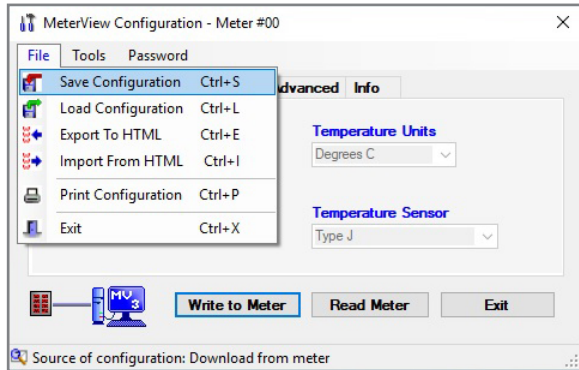

Data Acquisition

The PD8-765 makes a great front end to a PC-based data acquisition system. It is easy to set up, can be used for a wide range of inputs, will power the transmitter, and best of all provide a local display of the process. Precision Digital has the perfect package with its PD8-765, a wide selection of serial adapters and converters and free MeterView software. Data is displayed on the PC and written to a file that could then be imported into a spreadsheet or other application.

Data Logging up to 100 PD8-765 Meters

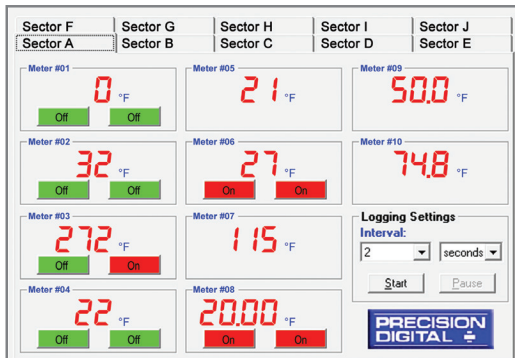

Sample File Generated by MeterView

PD8-765 Log File						
Name: C:\MV3\logfile.htm		Created: 5/7/2019 5:34:12 PM				
Serial Port: COM 1		Connection speed: 2400 Baud		Logging rate: 1 update every 10 seconds		
Date & Time	Tag Number	Address	Display	Units	Relay 1	Relay 2
1/7/2019 5:34:12 PM	Tank 1 Level	06	17.70	Feet	P1 On	P2 Off
1/7/2019 5:34:12 PM	Tank 2 Level	07	18.18	Feet	P3 Off	P4 Off
1/7/2019 5:34:12 PM	Tank 3 Level	08	20.54	Feet	P5 On	P6 Off
1/7/2019 5:34:12 PM	Tank 1 Temp	09	74	°F	Off	Off
1/7/2019 5:34:12 PM	Tank 2 Temp	10	72	°F	Off	Off
1/7/2019 5:34:12 PM	Tank 3 Temp	11	72	°F	Off	Off
1/7/2019 5:34:22 PM	Tank 1 Level	06	17.58	Feet	P1 On	P2 Off
1/7/2019 5:34:22 PM	Tank 2 Level	07	18.04	Feet	P3 Off	P4 Off
1/7/2019 5:34:22 PM	Tank 3 Level	08	19.79	Feet	P5 Off	P6 Off
1/7/2019 5:34:22 PM	Tank 1 Temp	09	74	°F	Off	Off
1/7/2019 5:34:22 PM	Tank 2 Temp	10	72	°F	Off	Off

Relays for Alarm & Control Applications

Adding relays to the PD8-765 meter turns it into a sophisticated alarm device as well as a powerful, yet simple, alternative to a more complicated PLC system for control applications. One such application would be pump control using the PD8-765's relays in pump alternation mode. The PD8-765 can be equipped with two 3 A Form C (SPDT) internal relays. Relays are highly user-configurable as the following MV screen shot indicates:

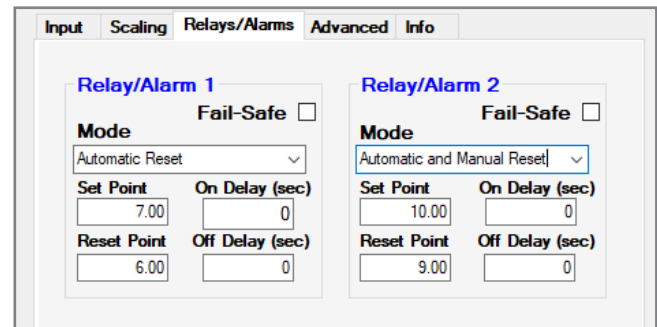

MeterView Software Specifications

System Requirements: Windows® 95/98/ME/NT4/2000/XP/ Vista/7*/ Windows® 10

Communications: Onboard RS-485 (standard feature)

Number of Meters: Up to 100 meters simultaneously with addressing capability; minimum scan time for 100 meters: 60 sec

Meter Address: 00 to 99

Baud Rate: 300 bps to 19,200 bps; selection must match the baud rate selected in the meters.

Screen Update Rate: Dependent on system and meter settings. Rates of up to 10 meters/second are attainable at 19,200 bps.

Configuration: Configure meter settings one meter at a time.

Configuration Report: Save configuration to PDC file format or export to HTML for printing, cloning, or restoring meter.

Logging Interval: 2 seconds to 60 hours or manual

Manual Logging: Data saved to file when Log button is pressed.

Data Logging Report: Log data to HTML file format. All enabled meters are logged to a single file.

Alarm Notification: Pop-up message indicates new alarm condition. Alarm alert notification may be disabled.

Event Log: Important events are logged with date and time stamp.

Relay/Alarm Status: Indicate relay/alarm status with customized color and message label. Relay status indication may be disabled.

Units & Tag Number: Show engineering units and tag number information; these settings are not saved to the meter.

Relay Acknowledge: Relays may be acknowledged by clicking on corresponding Relay Status button. Meters must be set up for manual reset and Relay Mode must be enabled in MeterView.

**Note: Windows 32-bit operating systems only*

CAPTOUCH THROUGH-GLASS BUTTONS

The ProtEX-MAX is equipped with four capacitive sensors that operate as through-glass buttons so that they can be operated without removing the cover (and exposing the electronics) in a hazardous area or harsh environment. CapTouch buttons are designed to protect against false triggering and can be disabled for security by selecting DISABLE on the switch labeled NO-CONTACT BUTTONS located on the connector board.

CapTouch Buttons

To actuate a button, press one finger to the window directly over the marked button area. When the cover is removed or replaced, the CapTouch buttons can be used after the meter completes a self-calibrating routine. The sensors are disabled when more than one button is pressed, and they will automatically re-enable after a few seconds. When the cover is removed, the four mechanical buttons located on the right of the faceplate are used.

The CapTouch Buttons are configured by default to duplicate the function of the front panel mechanical pushbuttons associated with the integrated meter.



4-20 MA OUTPUT & RELAYS

Isolated 4-20 mA Analog Output

There are several uses for the PD8-765's isolated 4-20 mA output. For temperature applications, the isolated 4-20 mA output option turns the PD8-765 into an explosion-proof temperature transmitter with a huge display! For 4-20 mA input applications the isolated 4-20 mA output turns the PD8-765 into a signal isolator with the convenience of local display of the process variable. The 4-20 mA output can also be reversed scaled.

Linear 4-20 mA Analog Output

For applications where the input was linearized by the PD8-765, the 4-20 mA output will represent that linearized value.

Convert Temperature Inputs to 4-20 mA Output with the PD8-765

The PD8-765, with the appropriate options, can be used as an isolated, explosion-proof, temperature transmitter with a big display by converting the thermocouple or RTD input into an isolated 4-20 mA output.

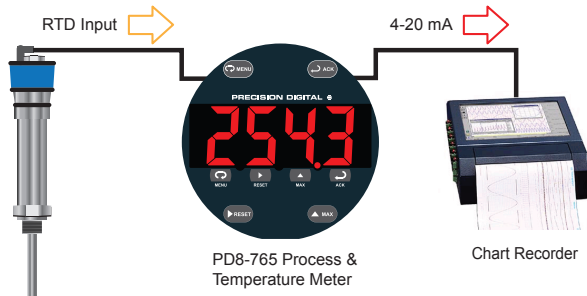

The 4-20 mA output can be reversed scaled such that 4 mA represents the high value and 20 mA represents the low value. For instance, a 4-20 mA output signal could be generated as the meter went from 100.0 to 0.0.

PD8-765 Provides 500 V of Isolation on the Output

The inputs and outputs of the PD8-765 ProtEX-MAX are electrically isolated to prevent ground loops and make wiring easier. All inputs, outputs and power supplies are fully isolated from one another.

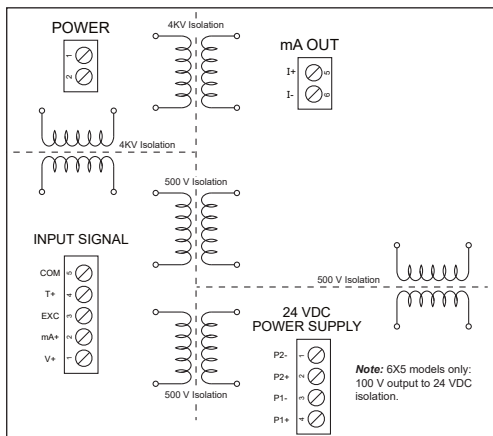

Connections

The PD8-765 can provide 40 mA at 24 VDC to power the 4-20 mA output signal or an external power supply can be used:

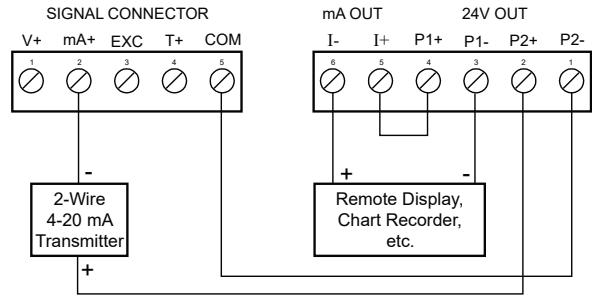

4-20 mA Output & Input Signal Powered by Meter

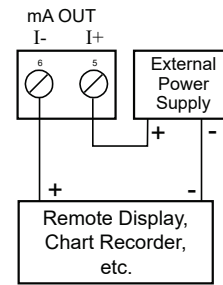

4-20 mA Output Powered Externally

The 4-20 mA output can either be programmed using the front panel push buttons or free MeterView software.

MeterView Software Programming

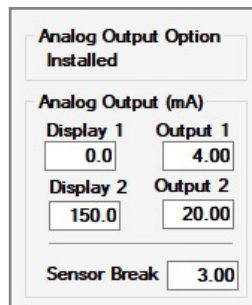

When a meter is programmed as shown to the left, the output will be 4.00 mA when the display reads 0.0 and the output will be 20.00 mA when the display reads 150.0.

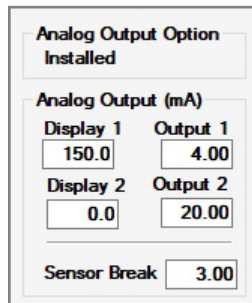

The meter can be set up for reverse scaling as shown to the left: the output will be 4.00 mA when the display reads 150.0 and the output will be 20.00 mA when the display reads 0.0

Sensor Break: Analog output value when TC or RTD sensor break is detected.

Relays for Alarm & Control Applications

Adding relays to the PD8-765 meter turns it into a sophisticated alarm device as well as a powerful, yet simple, alternative to a more complicated PLC system for control applications. One such application would be pump control using the PD8-765's relays in pump alternation mode. The PD8-765 can be equipped with two 3 A Form C (SPDT) internal relays. The relays are highly user-configurable as the following screen shot from MeterView indicates:

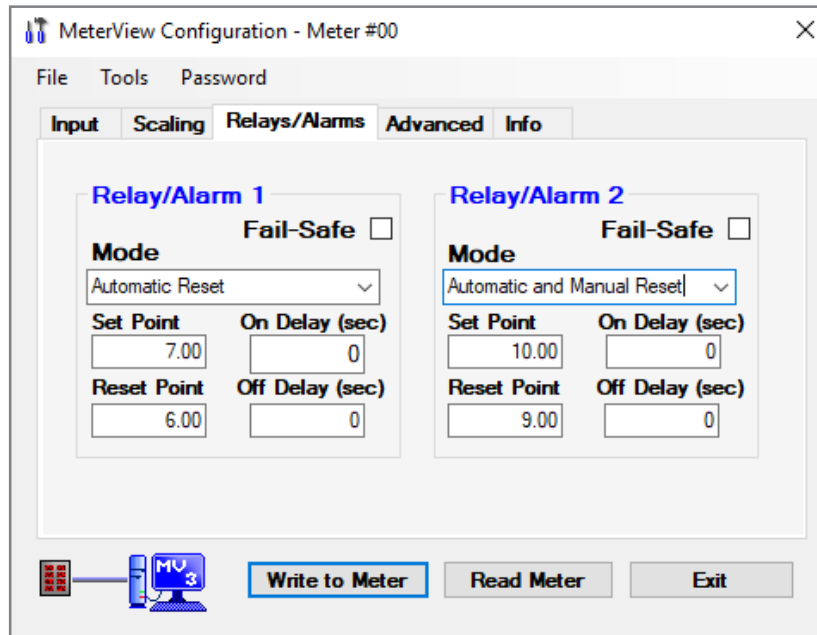

Setting Set and Reset Points (HI / LO Alarms)

All relays are independent of each other and may be programmed as high or low alarms with user desired set and reset points. Setting a set point above a reset point results in a high alarm and setting a set point below a reset point results in a low alarm. Alarms have 0 – 100% deadband and set and reset points may be set anywhere in the range of the meter.

Resetting the Relays (Mode in MV)

All relays are independent of each other and may be programmed to reset (Mode in MV) in the following ways:

- **Automatic:** Alarm will reset automatically once the alarm condition has cleared.
- **Automatic/Manual:** Alarm will reset automatically once the alarm condition has cleared but can also be reset using the ACK front panel button* at any time.
- **Latching:** Alarm must be reset manually and can be done so at any time. Press the ACK front panel button* at any time to clear the alarm.
- **Latching with Reset after Cleared:** Alarm must be reset manually and can only be done so after the alarm condition has cleared. Press the ACK front panel button* after the alarm condition has cleared to reset the alarm.

* Or by connecting an external button to terminal 4 on the external button contacts.

Time Delay (On and Off)

In many applications it is desirable to wait before turning off or on a relay – such as waiting for a process to settle before taking action. Each relay on the ProtEX-MAX PD8-765 can be programmed independently with on and off time delays of 0 to 999.9 seconds to achieve this.

Relays Auto Initialization

When power is applied to the meter, the front panel LEDs and alarm relays will reflect the state of the input to the meter.

Signal Loss Relay Operation (Sensor Break)

The meter can be programmed so that when it detects a break in the RTD or thermocouple signal, the relay will go to either the alarm or non-alarm state.

Note: This does not apply to voltage or 4-20 mA signals.

User Selectable Fail-Safe Operation

All relays are independent of each other and may be programmed for user selectable fail-safe operation. With the fail-safe feature activated, the relays will transfer to the alarm state on power loss to the meter.

Relay Connections

Relay connections are made to a six-terminal connector labeled RELAY1 and RELAY2.

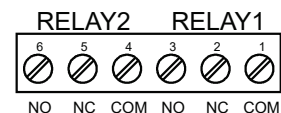

Explosion-Proof Pump Controller with Dual-Pump Alternation

The PD8-765 can be used as an explosion-proof pump controller when combined with a continuous level transmitter. One of the most common pump control application is shown below: controlling and alternating two pumps. The goal is to control the level between 1000 and 6000 gallons. The main pump turns on when the level reaches 6000 gallons and pumps down to 1000 gallons and then shuts the pump off. The next cycle, the backup pump turns on at 6000 gallons and shuts off at 1000 gallons. If at any time the active pump can't keep the level below 7000 gallons, the other pump would come on also.

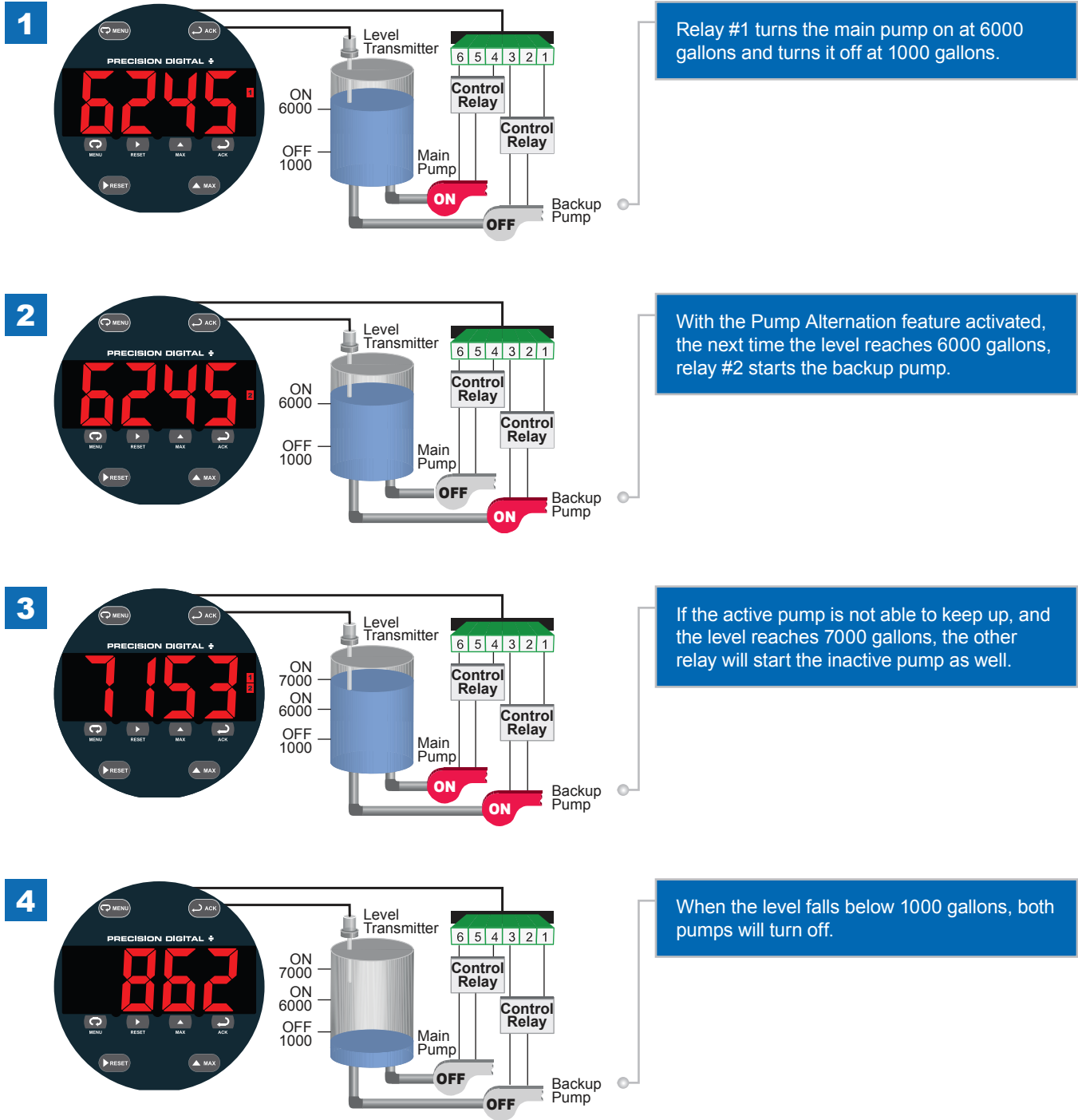

If more than 2 relays are needed, consider the PD8-6000 ProtEX-MAX meter. Visit predig.com/PD8-6000 for details.

SERIAL COMMUNICATIONS

Modbus® RTU Serial Communications

With onboard RS-485 serial communication, the PD8-765 can communicate with any Modbus *master* device using the popular Modbus communications protocol that is included in every PD8-765.



Click here for more information on the PD8-765's Modbus capabilities

Serial Adapters & Converters*



PDA7420
Trident Meter Copy Cable



PDA8006
USB Serial Adapter for Programming Meter with MeterView Software



PDA8485-I
USB to RS-422/485 Isolated Converter



PDA7485-I
RS-232 to RS-422/485 Isolated Converter

*All adapters and converters are sold separately and supplied with appropriate cables.



For more information on serial converters click here.

Integrated External Button Contacts and Serial Communications

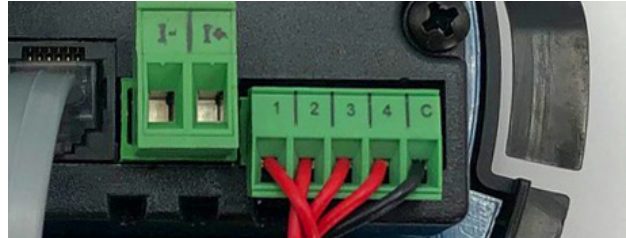

External Button Connections

Four external button contacts come standard with the ProtEX MAX PD8-765. These button contacts are used to remotely operate the front panel buttons and can be used for programming and resetting the relays.

Note: The integrated button contacts (1-4) function identically to the front panel pushbuttons / CapTouch buttons (Menu, Reset, Max, & ACK) and are non-configurable.



Serial Communications Connections

PD8-765 meters come with an RS-485 connection for serial communications with other digital devices. The industry standard Modbus RTU protocol is included with every meter.

PHYSICAL FEATURES

The ProtEX-MAX is designed for ease-of-use in safe and hazardous area applications, and is housed in a rugged NEMA 4X explosion-proof enclosure, available in either aluminum or stainless steel. The PD8-765 can operate over a wide temperature range (-55 to 65°C / -67 to 149°F), includes removable screw terminal connectors, and features through-glass buttons for easy meter operation without the need to remove the cover. All of these features are backed by a 3-year warranty.

Super-Bright LED Display

The PD8-765 features a 1.2" high 4-digit display with super-bright LEDs, our brightest ever. These allow the display to be read in any lighting condition, even in direct sunlight.



CapTouch Through-Glass Buttons

The ProtEX-MAX is equipped with four capacitive sensors that operate as through-glass buttons so that it can be programmed and operated without removing the cover (and exposing the electronics) in a hazardous area. These buttons can be disabled for security by selecting the DISABLE setting on the NO-CONTACT BUTTONS switch located on the back of the electronics module, inside the enclosure.

Rugged Explosion-Proof Enclosure

The ProtEX-MAX is housed in a rugged NEMA 4X, 7, & 9, IP68 aluminum or stainless steel enclosure, designed to withstand harsh environments in safe and hazardous areas.



Wide Viewing Angle

Customers can't always look at the display from straight on, so the window and display module have been optimized to provide a wide viewing angle of approximately $\pm 40^\circ$; nearly twice that of the competition.



Built-In Mounting Flanges

The ProtEX-MAX is equipped with two slotted flanges for wall mounting or NPS 1½" to 2½" or DN 40 to 65 mm pipe mounting.



Flexible Mounting & Wiring

The PD8-765 features four ¾" NPT conduit openings so that wiring can be routed to the most convenient conduit connection(s).

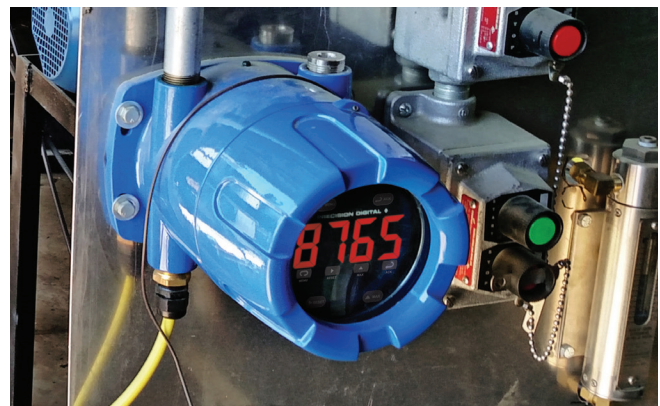

Rotatable Display

The PD8-765 rotatable display, along with four available conduit connections, provide for numerous installation options. The display can be rotated in 90° increments. Rotate it 90° for horizontal mounting.



Vertical Mounting



Horizontal Mounting

Perfect & Secure Fit Every Time

The internal cast rails ensure the ProtEX-MAX assembles together perfectly, quickly and securely; and everything lines up for optimal viewing every time. There are no standoffs to worry about breaking or getting out of alignment. The display module snaps into the built-in rails on the enclosure making assembly a snap, while pressing the display as close to the glass as possible to improve wide angle viewing. No tools are needed to install or remove it.

PDA-SSTAG Stainless Steel Tags

PDA-SSTAG is a laser etched stainless steel tag accessory for any Precision Digital meter. The tag features custom text for equipment identification, instruction, or whatever else is needed in your facility. Each tag comes with a stainless steel wire and lead seal for easy mounting wherever you need it.



Hazardous Area Certification

The ProtEX-MAX is certified by CSA as Explosion-Proof / Dust-Ignition-Proof / Flame-Proof and is approved by ATEX and IECEx as Dust-Ignition-Proof / Flame-Proof.

Wide Operating Temperature Range

The ProtEX-MAX can operate from -55 to 65°C (-67 to 149°F) meaning it can be installed in a wide variety of indoor and outdoor industrial applications.



Removable Screw Terminal Connectors

Industrial applications require screw terminal connections for easy field wiring and the PD8-765 goes one step further in convenience by also making them removable.

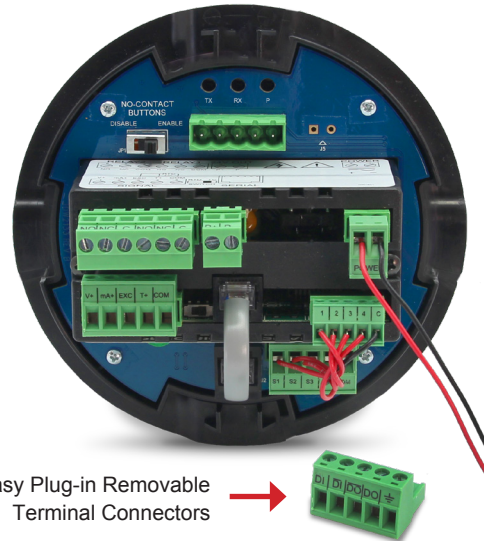

Easy Plug-in Removable Terminal Connectors

VIDEOS TO WATCH



ProtEX-MAX Explosion-Proof

See all the features ProtEX-Max has to offer for the PD8-765 and other explosion-proof instruments.

Videos can be found at predig.com/videos

OPERATIONAL FEATURES

CapTouch Buttons & External Button Contacts

The main function of the CapTouch buttons during operation is to display the maximum and minimum readings reached by the process or temperature inputs as well as acknowledge relays.

1. CapTouch Button Functions

The following CapTouch buttons can perform these functions:



Reset Max/Min Reading

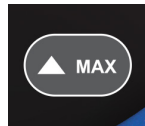

Display Max/Min Reading

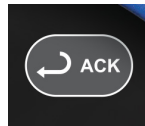

Acknowledge Relays

2. Front Buttons Behind Glass

The front buttons behind the glass can be used to manually program the PD8-765 meter by removing the front cover. A more convenient way is to use the CapTouch buttons or MeterView software. See manual for details.



3. External Button Contacts Available on PD8-765

The PD8-765 is equipped with four external button contacts that can be connected to another device to remotely program and operate the instrument.

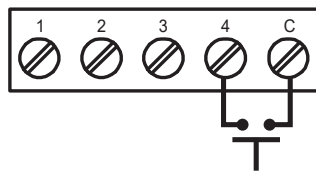

Terminal	Programming	Operation
1	Menu	
2	Right Arrow	Reset Max/Min
3	Up Arrow	Display Max/Min
4	Enter	Acknowledge Relays

DIMENSIONS

Units: Inches (mm)

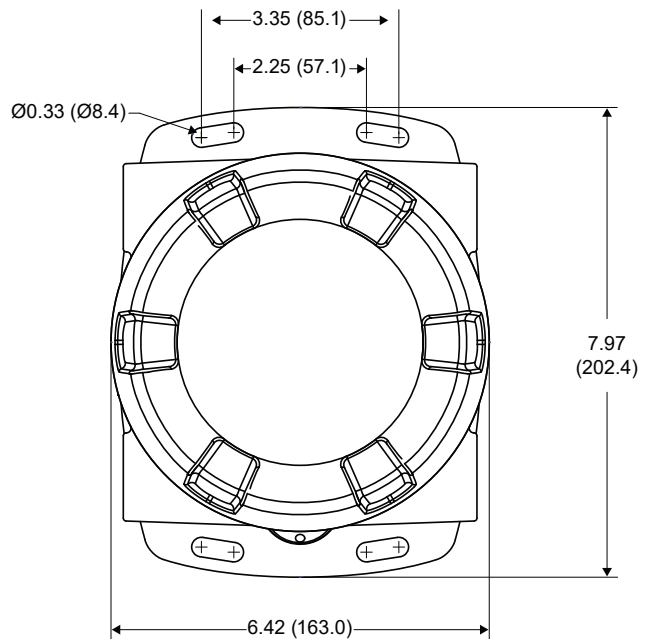
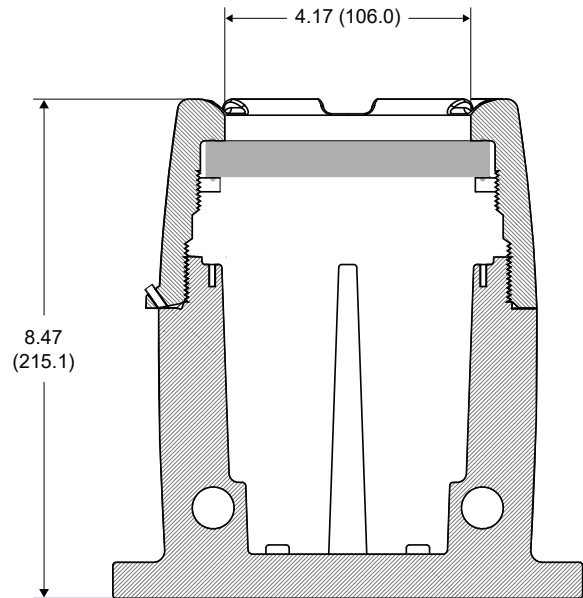

Download free 3-D CAD files of these instruments to simplify your drawings!

predig.com/documentation-cad

ACCESSORIES

PD9501 Multi-Function Calibrator

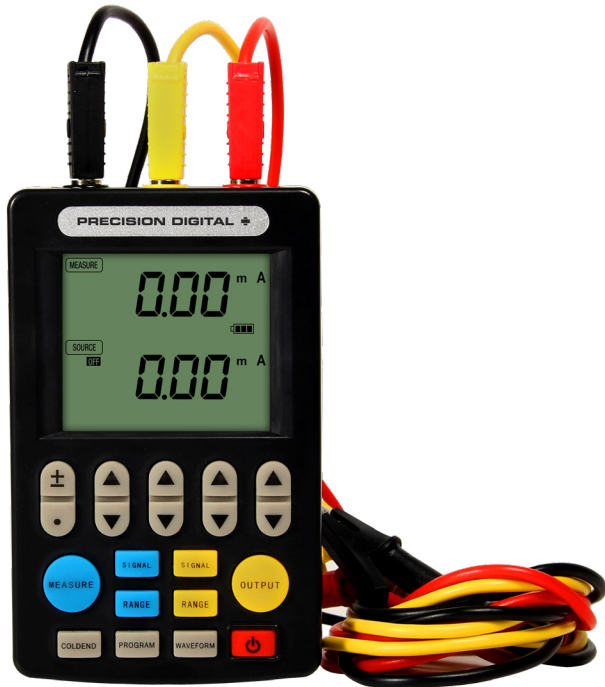

Overview

This PD9501 Multi-Function Calibrator has a variety of signal measurement and output functions, including voltage, current, thermocouple, and RTD.

Main Function

Voltage Signal: 0-30 V, 0-25 mV, 0-100 mV output and measurement.

Current Signal: Active and passive 0-25 mA, 4-20 mA output and measurement.

Thermocouple: K, E, J, T, R, B, S, N output and measurement. *Note: Output Range Starts from 0°C*

RTD: PT100 output and measurement.

Ohms: Output and measurement

Features

- Measure and Source T/Cs, RTDs, Ohms, Current, Voltage
- Compact & Lightweight
- Battery or USB Powered
- Descriptive LCD Display
- 24 V Power to Drive the Transmitter
- Auto Stepping & Auto Ramping
- Selective Auto Off Mode
- LCD includes an LED backlight

PD9502 4-20 mA / 0-10 VDC Low-Cost Signal Generator



PD9502 with Supplied Cables

Overview

The PD9502 is a low-cost, compact, simple to use 4-20 mA or 0-10 VDC signal generator. It can easily be set for 0-20 mA, 4-20 mA, 0-10 V or 2-10 V ranges. Signal adjustment is made with a one-turn knob. A 15-27 VDC wall plug is provided with the instrument. Optional USB power bank is available.

Features

- 0-20 / 4-20 mA or 0-10 / 2-10 VDC Ranges
- Low-Cost
- Simple to Use
- Compact Size
- 4-Digit LED Display
- One-Turn Adjustment Knob
- ±0.5% ±1 Count Accuracy
- Power 15-27 VDC or USB Power Bank

Complete Product Line of Displays and Controllers IN ALL SHAPES, SIZES & LOCATIONS



Big, Bright Displays
For Indoor or Outdoor
in Bright Sunlight



Large Dual-Line
6-Digit Display



24 VDC
Transmitter
Power Supply



MeterView® Pro USB
Programming Software



Universal 85-265
VAC or 12-24 VDC
Input Power
Options



4-20 mA, 0-10 V,
Thermocouple, RTD,
Strain Gauge, High
Voltage, & Modbus Inputs



Up To Four
3 A Form C
Relays (SPDT)



SP Ex CE IECEx

EXPLOSION-PROOF ProtEX-MAX Series

- NEMA 4X, IP68 Rated Enclosure
- CapTouch Through-Glass Buttons
- Operating Temperature of -55 to 65°C
- Worldwide Approvals

LARGE DISPLAYS Helios Series

- 1.8" Digits Readable From 100 Feet
- NEMA 4X, IP65 Rated Enclosure
- Operating Temperature of -40 to 65°C
- Now UL and C-UL Approved!

CE UL

PANEL METERS ProVu Series

- NEMA 4X, IP65 Rated Front
- Programmable Function Keys
- UL, C-UL, and CE Approvals
- 1/8 DIN Size

Go to PREDIG.COM for details on ProVu, ProtEX-MAX and Helios Series Meters

CONNECTIONS

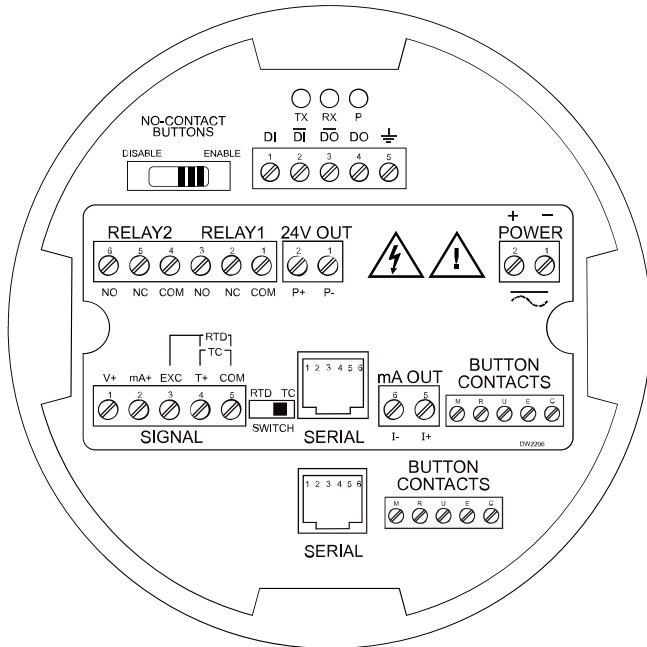

Connections on Back of PD8-765 Electronics Module (PD8-765-6X5-10 shown)

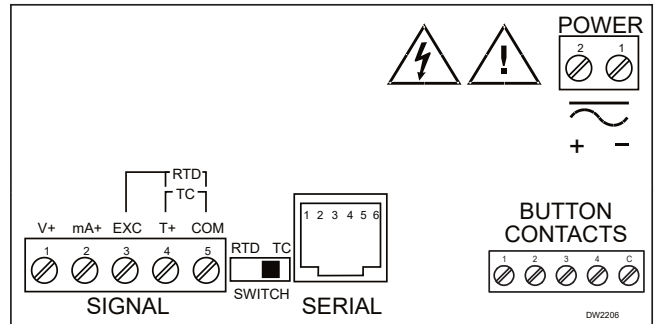

PD8-765-7X0-00

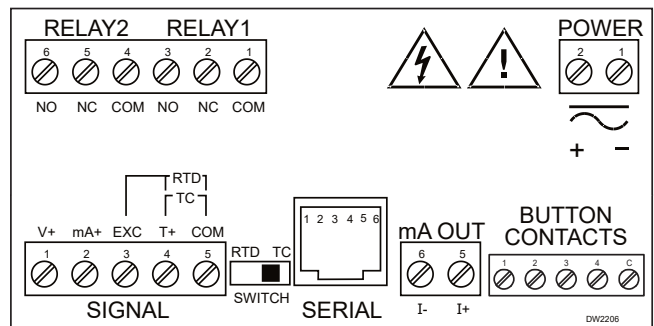

PD8-765-7X5-00

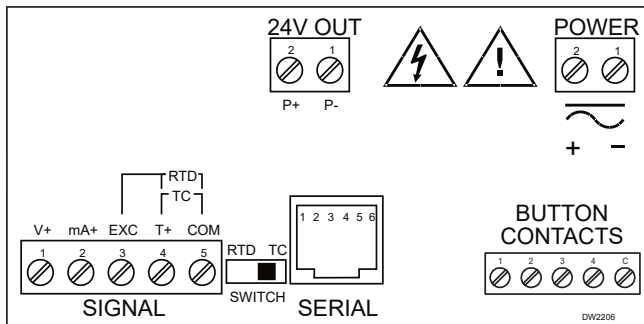

PD8-765-6X0-10

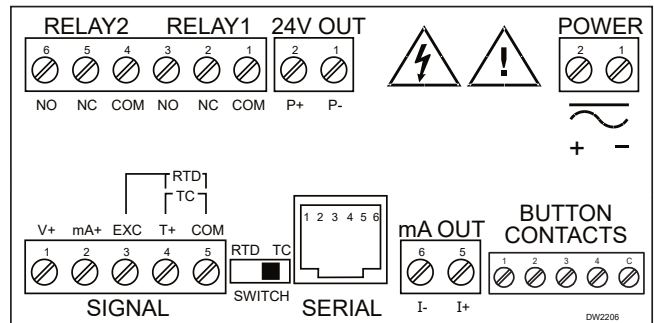

PD8-765-6X5-10

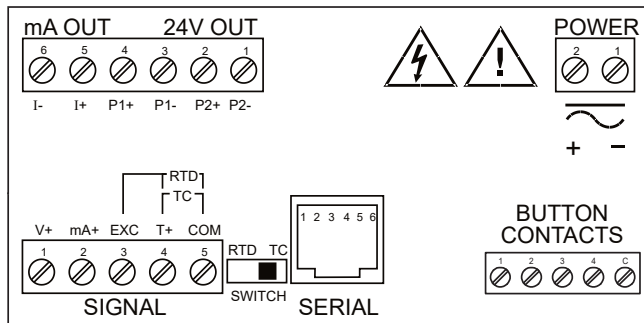

PD8-765-6X3-20

SPECIFICATIONS

Except where noted all specifications apply to operation at +25°C.

General

Display	1.20" (31 mm), red LED, four digits (-1999 to 9999), automatic lead zero blanking.
Display Intensity	Eight user selectable intensity levels. Default intensity is six.
Display Update Rate	Process/RTD: 3.7-5/second Thermocouple: 1.8-2.5/second
Overrange	Display flashes 9999
Underrange	Display flashes -1999
Programming Methods	Four CapTouch through-glass buttons when cover is installed. Mechanical buttons can be used with the cover removed. Cloning with Copy feature. Free PC-based USB MeterView programming software, and Modbus registers.
Noise Filter	Programmable from 2 to 199 (0 will disable filter)
Filter Bypass	Programmable from 0.1 to 99.9% of calibrated span
Recalibration	All ranges are calibrated at the factory. Recalibration is recommended at least every 12 months.
Max/Min Display	Max/min readings reached by the process are stored until reset by the user or until power to the meter is turned off.
Password	Restricts modification of programmed settings
Non-Volatile Memory	All programmed settings are stored in non-volatile memory for a minimum of ten years if power is lost.
Power Options	85-265 VAC, 50/60 Hz; 90-265 VDC, 20 W max or 12-36 VDC; 12-24 VAC, 6 W max
Fuse	Required external fuse: UL Recognized, 5 A max, slow blow; up to 6 meters may share one 5 A fuse
Normal Mode Rejection	64 dB at 50/60 Hz
Isolation	4 kV input/output-to-power line 500 V input-to-output or output-to-P+ supply 6X5 models only: 100 V output-to-24 VDC supply
Overvoltage Category	Installation Overvoltage Category II: Local level with smaller transient overvoltages than Installation Overvoltage Category III
Environmental	T6 Class operating temperature range Ta = -55 to 60°C T5 Class operating temperature range Ta = -55 to 65°C Storage temperature range: -55 to 85°C (-67 to 185°F) Relative humidity: 0 to 90% non-condensing
Connections	Power, signal, relays, mA out: Removable screw terminal blocks accept 12 to 22 AWG wire RS-485: Removable screw terminal block accepts 16 to 30 AWG wire
Mounting	Wall Mounting: Four (4) mounting holes provided for mounting meter to wall. Pipe Mounting: Optional pipe mounting kit (PDA6848) allows for pipe mounting. Sold separately.

Tightening Torque	Screw terminal connectors: 5 lb-in (0.56 Nm)
Overall Dimensions	6.42" x 7.97" x 8.47" (W X H X D) (163 mm x 202 mm x 215 mm)
Weight	Aluminum: 14.7 lbs (6.67 kg) Stainless Steel: 23.5 lbs (10.66 kg)
Warranty	3 years parts & labor. See Warranty Information and Terms & Conditions on www.predig.com for complete details.

Process Inputs

Inputs	0-20 mA, 4-20 mA, 1-5 V, ±10 V	
Transmitter Supply	Isolated, one or two transmitter supplies P1: 24 VDC ±10% @ 200 mA max (-10 option) P1 & P2: 24 VDC ±10% @ 200 mA & 40 mA max (-20 option)	
Accuracy	±0.05% FS ±1 count; ±0.1% FS ±2 counts for square root	
Function	Linear or square root	
Low-Flow Cutoff	0 to 9999 (0 disables cutoff function) Point below at which display always shows zero	
Decimal Point	Up to 3 decimals	
Calibration	Scale without signal or calibrate with signal source	
Calibration Range	User programmable over entire range of meter	
Input Impedance	Voltage range: greater than 1 MΩ, Current range: 50-100 Ω, varies with resettable fuse impedance	
Input Overload	Protected by automatically resettable fuse	
HART Transparency	The meter does not interfere with existing HART communications; it displays the 4-20 mA primary variable and allows the HART communications to pass through without interruption. The meter is not affected if a HART communicator is connected to the loop. The meter does not display secondary HART variables.	
Temperature Drift	0 to 65°C ambient Current: ±0.20% FS (50 PPM/°C) Voltage: ±0.02% FS (1.7 PPM/°C)	-40 to 0°C ambient Current: ±0.80% FS Voltage: ±0.06% FS

Temperature Inputs

Inputs	Factory calibrated, field selectable: type J, K, T, or E thermocouples and 100 Ω platinum RTD (0.00385 or 0.00392 curve)
Resolution	1°; type T TC & RTD: 1° or 0.1°
Cold Junction Reference	Automatic
Temp Drift	±2°C maximum
Offset Adjustment	Programmable to ±19.9°. This parameter allows the user to apply an offset value to the temperature being displayed.
Input Impedance	Greater than 100 kΩ

Accuracy

Input Type	Range	Accuracy (0 - 65°C)	Accuracy (-40 - 0°C)	Resolution
J	-58 to 1382°F -50 to 750°C	±2°F ±1°C	±5°F ±3°C	1°
K	-58 to 2300°F -50 to 1260°C	±2°F ±1°C	±4°F ±2°C	1°
T	-292 to 700°F -180 to 371°C	±2°F ±1°C	±13°F ±7°C	1° or 0.1°
E	-58 to 1700°F -50 to 927°C	±2°F ±1°C	±11°F ±6°C	1°
RTD	-328 to 1382°F -200 to 750°C	±1°F ±1°C	±5°F ±3°C	1° or 0.1°

Relays Option

Rating	2 Form C (SPDT); rated 3 A @ 30 VDC or 3 A @ 250 VAC resistive load; 1/14 HP (≈ 50 watts) @ 125/250 VAC for inductive loads such as contactors, solenoids, etc.
Deadband	0-100% FS, user selectable
Electrical Noise Suppression	A snubber should be connected to each relay contact switching inductive loads to prevent disruption to the microprocessor's operation. Recommended snubber value: 0.01 μF/470 Ω, 250 VAC (PDX6901).
High or Low Alarm	User may program any alarm for high or low
Relay Operation	<ul style="list-style-type: none"> Automatic (non-latching) and/or manual reset Latching (requires manual acknowledge) with/without clear Pump alternation control Off (disable unused relays)
Relay Reset	Front panel button, terminal at back of meter or through serial communications
Time Delay	0 to 199 seconds, on and off delays; programmable
Sensor Break Relay Operation	The sensor break relay condition may be programmed for each relay as On (alarm) or Off (non-alarm). The relays will enter these states when a sensor break is detected for RTD or thermocouple inputs. These settings have no effect when current or voltage inputs are selected.
Fail-Safe Operation	Programmable, independent for each relay. Relay coils are energized in non-alarm condition. In case of power failure, relays will go to alarm state.
Auto Initialization	When power is applied to the meter, relays will reflect the state of the input to the meter.

External Button Contacts

Number	Four
Function	Remote operation of front-panel buttons: programming, reset relays or view/reset max/min readings
Open State	+5 VDC open contact on button input terminals
Closed State	Closed contact button input terminal to common/ground, active low 0 to 0.4 VDC

Isolated 4-20 mA Transmitter Output

Scaling Range	1.000 to 23.000 mA; reverse scaling allowed		
Calibration	Factory calibrated for 4-20 mA		
Accuracy	± 0.1% of span ± 0.004 mA		
Temperature Drift	50 PPM/°C Note: Analog output drift is separate from input drift.		
Isolation	500 V input-to-output or output-to-24 VDC supplies 4 kV output-to-power line For -6X5 models only: 100 V output-to-24 VDC supply		
External Power	35 VDC maximum		
Output Loop Resistance	Power Supply	Minimum	Maximum
	24 VDC	10 Ω	700 Ω
	35 VDC (external)	100 Ω	1200 Ω

RS-485 Serial Communications

Compatibility	EIA-485
Connectors	Removable screw terminal connector
Max Distance	3,937' (1,200 m) max
Status Indication	Separate LEDs for Transmit (TX) and Receive (RX)

Modbus® RTU Serial Communications

Slave Id	1 – 247 (Meter address)
Baud Rate	300 – 19,200 bps
Transmit Time Delay	Programmable between 0 and 199 ms
Data	8 bit (1 start bit, 1 stop bit)
Parity	None (1 or 2 stop bits), even, or odd (Modbus only; PDC protocol does not use parity)
Byte-To-Byte Timeout	0.01 – 2.54 second
Turn Around Delay	Less than 2 ms (fixed) Note: Refer to the ProtEX-MAX Modbus Register Tables located at www.predig.com for details.

Enclosure

Material	AL Models: ASTM A413 LM6 die-cast aluminum, copper-free, enamel coated SS Models: ASTM A743 CF8M investment-cast 316 stainless steel
Gasket	Fluoroelastomer
Rating	NEMA 4X, IP68 Explosion-proof
Color	AL: Blue SS: Silver
Window	Borosilicate glass
Conduits	Four ¾" NPT threaded conduit openings
Conduit Stopping Plugs	Sold separately
Flanges	Two built-in flanges for wall and pipe mounting
Tamper-Proof Seal	Cover may be secured with tamper-proof seal
Overall Dimensions	6.42" x 7.97" x 8.47" (W x H x D) (163 mm x 202 mm x 215 mm)
Weight	AL: 14.7 lbs (6.67 kg) SS: 23.5 lbs (10.66 kg)
ATEX	Ⓔ II 2 G D Ex db IIC Gb Ex tb IIIC Db IP66/IP68 Tamb: -55°C to +85°C Certificate No.: Sira 19ATEX1252U
IECEX	Ex db IIC Gb Ex tb IIIC Db IP66/IP68 Tamb: -55°C to +85°C Certificate No.: IECEX SIR 19.0075U
CSA	Class I, Division 1, Groups A, B, C, D Class II, Division 1, Group E, F, G Class III Ex db IIC Gb Ex tb IIIC Db Class I, Zone 1, AEx db IIC Gb Zone 21, AEx tb IIIC Db IP66/IP68/TYP4X Tamb: -55°C to +85°C Certificate No.: CSA19.80011200U
UL	Class I, Division 1, Groups A, B, C, D Class II, Division 1, Groups E, F, G Class III Class I, Zone 1, AEx db IIC Gb Zone 21, AEx tb IIIC Db Ex db IIC Gb Ex tb IIIC Db IP66/IP68/TYP4X Tamb: -55°C to +85°C Certificate Number: E518920

Note: The above approvals are for the enclosure only. See next page for approvals on the entire instrument.

General Compliance Information

Electromagnetic Compatibility

Emissions	EN 55022 Class A ITE emissions requirements
Radiated Emissions	Class A
AC Mains Conducted Emissions	Class A
Immunity	EN 61326-1 Measurement, control, and laboratory equipment EN 61000-6-2 EMC heavy industrial generic immunity standard
RFI - Amplitude Modulated	80 -1000 MHz 10 V/m 80% AM (1 kHz) 1.4 - 2.0 GHz 3 V/m 80% AM (1 kHz) 2.0 - 2.7 GHz 1 V/m 80% AM (1 kHz)
Electrical Fast Transients	±2kV AC mains, ±1kV other
Electrostatic Discharge	±4kV contact, ±8kV air
RFI - Conducted	10V, 0.15-80 MHz, 1kHz 80% AM
AC Surge	±2kV Common, ±1kV Differential
Surge	1KV (CM)
Power-Frequency Magnetic Field	30 A/m 70%V for 0.5 period
Voltage Dips	40%V for 5 & 50 periods 70%V for 25 periods
Voltage Interruptions	<5%V for 250 periods

Note: Testing was conducted on meters with cable shields grounded at the point of entry representing installations designed to optimize EMC performance.

Product Ratings and Approvals

CSA Class I, Division 1, Groups B, C, D
 Class II, Division 1, Groups E, F, G
 Class III, Division 1, T5
 Class III, Division 1, T6 (Ta max = 60°C)
 Ex db IIC T5
 Ex db IIC T6 (Ta max = 60°C)
 Ex tb IIIC T90°C
 Ta = -55°C to +65°C
 Enclosure: Type 4X & IP66 / IP68
 CSA Certificate: CSA 12 2531731

ATEX  II 2 G D
 Ex db IIC T* Gb
 Ex tb IIIC T90°C Db IP68
 Ta = -55°C to +*°C
 *T6 = -55°C to +60°C
 *T5 = -55°C to +65°C
 Certificate Number: Sira 12ATEX1182X

IECEX Ex db IIC T* Gb
 Ex tb IIIC T90°C Db IP68
 Ta = -55°C to +*°C
 *T6 = -55°C to +60°C
 *T5 = -55°C to +65°C
 Certificate Number: IECEX SIR 12.0073X

ATEX/IECEX Specific Conditions of Use:

- The equipment label and epoxy coating may generate an ignition-capable level of electrostatic charges under certain extreme conditions. The user should ensure that the equipment is not installed in a location where it may be subjected to external conditions (such as high-pressure steam) which might cause a build-up of electrostatic charges on non-conducting surfaces. Additionally, cleaning of the equipment should be done only with a damp cloth.
- Flameproof joints are not intended to be repaired.
- All entry closure devices shall be suitably certified as "Ex d", "Ex t" and "IP66/68" as applicable. Suitable thread sealing compound (non-setting, non-insulating, non-corrosive, not solvent based, suitable for the ambient rating) must be used at the NPT conduit entries to achieve the IPx8 rating while maintaining the Ex protection concept.

Year of Construction

This information is contained within the serial number with the first four digits representing the year and month in the YYMM format.

For European Community

The ProtEX-MAX must be installed in accordance with the ATEX directive 2014/34/EU, and the product certificate Sira 12ATEX1182X.

WARNING

Cancer and Reproductive Harm - www.P65Warnings.ca.gov

Disclaimer

The information contained in this document is subject to change without notice. Precision Digital Corporation makes no representations or warranties with respect to the contents hereof, and specifically disclaims any implied warranties of merchantability or fitness for a particular purpose.

©2023 Precision Digital Corporation. All rights reserved.

ORDERING INFORMATION

ProtEX-MAX PD8-765 • Aluminum Enclosure		
85-265 VAC Model	12-36 VDC Model	Options Installed
PD8-765-6X0-10		24 VDC Transmitter Supply
PD8-765-6X3-20		4-20 mA Out + Dual 24 VDC Transmitter Supplies
	PD8-765-7X0-00	None
	PD8-765-7X5-00	2 Relays + 4-20 mA Output
PD8-765-6X5-10		2 Relays + 4-20 mA Output + 24 VDC Transmitter Supply

ProtEX-MAX PD8-765 • Stainless Steel Enclosure		
85-265 VAC Model	12-36 VDC Model	Options Installed
PD8-765-6X0-10-SS		24 VDC Transmitter Supply
PD8-765-6X3-20-SS		4-20 mA Out + Dual 24 VDC Transmitter Supplies
	PD8-765-7X0-00-SS	None
	PD8-765-7X5-00-SS	2 Relays + 4-20 mA Output
PD8-765-6X5-10-SS		2 Relays + 4-20 mA Output + 24 VDC Transmitter Supply

Accessories	
Model	Description
PDA7420	Trident Meter Copy Cable, 7' (2.1 m)
PDA7485-I	RS-232 to RS-422/485 Isolated Converter
PDA8006	USB Serial Adapter for Programming Meter with MeterView Software
PDA8485-I	USB to RS-422/485 Isolated Converter
PDA6848-SS	Pipe Mounting Kit Stainless Steel
PDAPLUG75	3/4" NPT 316 Stainless Steel Stopping Plug with Approvals
PDA-SSTAG	Stainless Steel Tag

Your Local Distributor is: